



DOSSIER TECHNIQUE IMMEUBLE AVANT PROJET DETAILLE

92-BAT-031EP
REF PM : 92-TEC-92E000173
18 AVENUE DE LA REPUBLIQUE 92420 Vaucresson

Proposition de câblage en fibre optique



Interlocuteur XPFBRE :	Bastien Chapotot		
Fiche Établie par :	CIRCET	Date :	15/05/2023

V6



DOSSIER TECHNIQUE IMMEUBLE AVANT PROJET DETAILLE

SYNDIC / BAILLEUR / PROPRIÉTAIRE	
Nom:	Monsieur PAOLI
Adresse:	
Téléphone:	06 07 54 31 29
Fax:	
Courriel:	oliverpaoli1@gmail.com

CONDITIONS D'ACCES	
Contact:	M.GASPAR / 06 28 07 77 15
Horaires:	
Digicode:	
Adresse complémentaire:	

INFORMATIONS IMMEUBLE	
Nombre de logements	140
Nombre de locaux professionnels	1
Nombre Total de prises	141
Nombre de cages d'escalier	9
Nombre de colonnes montantes	9
Type d'adduction immeuble:	SOUTERRAINNE
Emplacement de l'adduction	LOCAL MENAGE PARKING -2
Passage en partie privative	OUI
Percements nécessaires	OUI
Pose de fourreaux nécessaire	NON
Ouverture d'un coffrage nécessaire	NON
Présence Amiante	VOIR DTA
Date de réalisation des travaux	

Observations:	
aiguillage pas réalisé car CHAMBRE FT sur chaussée, l'adduction se trouve dans le local menage au niveau du parking SUPER U (R-2)	
Commentaires du gestionnaire	
Bon pour accord travaux :	
Fait à :	Le :
Signature du gestionnaire	

Interlocuteur XPFIBRE :	Bastien Chapotot		
Fiche Établie par :	CIRCET	Date :	15/05/2023

DOSSIER TECHNIQUE IMMEUBLE AVANT PROJET DETAILLE



Interlocuteur XFPBRE :	Bastien Chapotot
Fiche Etablie par :	CIRCET Date : 15/05/2023

DOSSIER TECHNIQUE IMMEUBLE AVANT PROJET DETAILLE

Plan des infrastructures Télécoms mobilisables

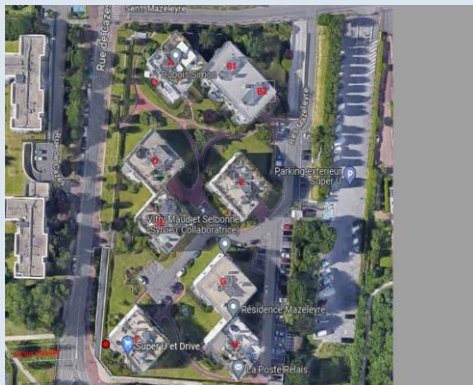

Légende :

Conduite ORANGE
Aérien ORANGE
Aérien ErDF
FACADE
Chemin interne



Légende :

Casse ou conduite bouchée





Interlocuteur XPRBRE :		Bastien Chapotot	
Fiche Établie par :	<i>CIRCET</i>	Date :	15/05/2023





DOSSIER TECHNIQUE IMMEUBLE AVANT PROJET DETAILLE

PHOTOS DU CHEMINEMENT DU PMI AUX PBO	
CHAMBRE FT SUR CHAUSSEE	CHAMBRE FT SUR CHAUSSEE
ADDUCTION ET POSE PBI-01 et BPI-02 au R-2 du BATE	VERS COLONNE AB1,B2,C,D,E,F,G et H
VERS COLONNE AB1,B2,C,D,E,F,G et H	VERS COLONNE AB1,B2,C,D,E,F,G et H
VERS COLONNE AB1,B2	VERS COLONNE AB1,B2
Interlocuteur XPFIbre : Fiche Etablie par :	Bastien Chapot Date : 15/05/2023
<i>CIRCET</i>	



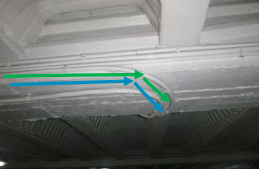

DOSSIER TECHNIQUE IMMEUBLE AVANT PROJET DETAILLE

PHOTOS DU CHEMINEMENT DU PMI AUX PBO	
VERS COLONNE A,B1,B2	VERS COLONNE A,B1,B2
	
VERS COLONNE A,B1,B2	VERS COLONNE A,B1,B2
	
VERS COLONNE A,B1 et B2	VERS COLONNE C,D,E,F,G,H
	
VERS COLONNE C,D,E,F,G,H	VERS COLONNES
	
Interlocuteur XPFIbre : Fiche Etablie par :	Bastien Chapotot Date :
<i>CIRCET</i>	15/05/2023

DOSSIER TECHNIQUE IMMEUBLE AVANT PROJET DETAILLE

PHOTOS DU CHEMINEMENT DU PMI AUX PBO	
VERS COLONNE C,D,E,F,G,H	VERS COLONNE C,D,E,F,G,H
	
VERS COLONNE C,D,E,F,G,H	VERS COLONNE C,D,E,F,G,H
	
VERS COLONNE C,D,E,F,G,H	
	
Interlocuteur XPFBRE :	Bastien Chapotot
Fiche Etablie par :	Date : 15/05/2023
<i>CIRCET</i>	

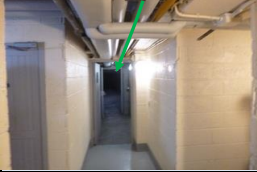
DOSSIER TECHNIQUE IMMEUBLE AVANT PROJET DETAILLE

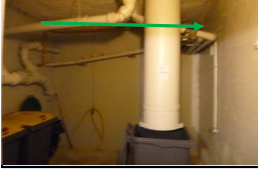
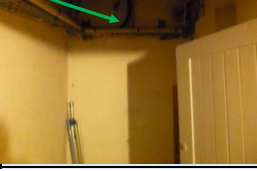
PHOTOS DU CHEMINEMENT DU PMI AUX PBO	
VERS COLONNE A B1,B2	PIED DE COLONNE A
	
VERS COLONNE B1,B2	VERS COLONNE B1,B2
	
VERS COLONNE B1,B2	VERS COLONNE B1
	
VERS COLONNE B1	PIED DE COLONNE B1
	
Interlocuteur XP FIBRE : Fiche Etablie par :	Bastien Chapotot Date : 15/05/2023
<i>CIRCET</i>	

DOSSIER TECHNIQUE IMMEUBLE AVANT PROJET DETAILLE

PHOTOS DU CHEMINEMENT DU PMI AUX PBO	
PIED DE COLONNE B1	VERS COLONNE B2
	
VERS COLONNE B2	VERS COLONNE B2
	
VERS COLONNE B2	VERS COLONNE B2
	
VERS COLONNE B2	PIED DE COLONNE B2
	
Interlocuteur XPFIbre : Fiche Etablie par :	Bastien Chapotot Date :
<i>CIRCET</i>	15/05/2023







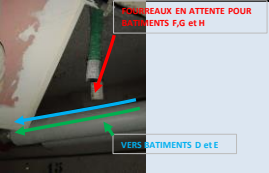

DOSSIER TECHNIQUE IMMEUBLE AVANT PROJET DETAILLE

PHOTOS DU CHEMINEMENT DU PMI AUX PBO	
<p>VERS COLONNE C,D,E,F,G,H</p> <p>PIED DE COLONNE C</p>	<p>VERS COLONNE C,D,E,F,G,H</p> <p>VERS COLONNE D,E,F,G,H</p>
<p>VERS COLONNE D,E,F,G,H</p>	<p>VERS COLONNE D,E,F,G,H</p>
<p>VERS COLONNE D,E,F,G,H</p>	<p>VERS COLONNE D,E,F,G,H</p>
<p>VERS COLONNE D,E,F,G,H</p>	<p>VERS COLONNE D,E,F,G,H</p>
<p>Interlocuteur XPFIBRE :</p> <p>Fiche Établie par :</p>	<p>Bastien Chapotot</p> <p>Date : 15/05/2023</p>

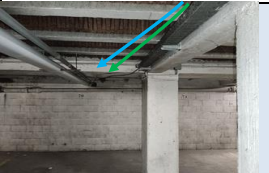

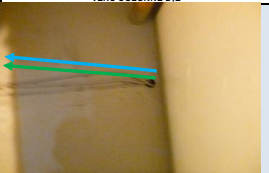



G

//

DOSSIER TECHNIQUE IMMEUBLE AVANT PROJET DETAILLE

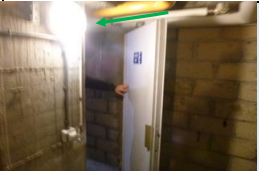
PHOTOS DU CHEMINEMENT DU PMI AUX PBO			
<p style="text-align: center; font-weight: bold; font-size: small;">VERS COLONNE D,E,F,G,H</p>  <p style="color: red; font-size: x-small; margin-left: 20px;">POSBREAUX EN ATTENTE POUR BATIMENTS F,G et H</p> <p style="color: blue; font-size: x-small; margin-left: 20px;">VERS BATIMENTS D et E</p>	<p style="text-align: center; font-weight: bold; font-size: small;">VERS COLONNE D,E</p> 		
<p style="text-align: center; font-weight: bold; font-size: small;">VERS COLONNE D,E</p> 	<p style="text-align: center; font-weight: bold; font-size: small;">VERS COLONNE D,E</p> 		
<p style="text-align: center; font-weight: bold; font-size: small;">VERS COLONNE D,E</p> 	<p style="text-align: center; font-weight: bold; font-size: small;">VERS COLONNE D,E</p> 		
<p style="text-align: center; font-weight: bold; font-size: small;">PIED DE COLONNE E</p> 	<p style="text-align: center; font-weight: bold; font-size: small;">VERS COLONNE D</p> 		
<p>Interlocuteur XPFIbre :</p> <p>Fiche Etablie par :</p>	<p style="text-align: center;"><i>CIRCET</i></p>	<p>Bastien Chapot</p> <p>Date :</p>	<p style="text-align: right;">15/05/2023</p>

DOSSIER TECHNIQUE IMMEUBLE AVANT PROJET DETAILLE

PHOTOS DU CHEMINEMENT DU PMI AUX PBO	
VERS COLONNE D 	VERS COLONNE D 
VERS COLONNE D 	VERS COLONNE D 
VERS COLONNE D 	VERS COLONNE D 
VERS COLONNE D 	VERS COLONNE D 
Interlocuteur XPRIBRE : Fiche Etablie par :	Bastien Chapotot Date :
<i>CIRCET</i>	15/05/2023

DOSSIER TECHNIQUE IMMEUBLE AVANT PROJET DETAILLE

PHOTOS DU CHEMINEMENT DU PMI AUX PBO	
VERS COLONNE D	PIED DE COLONNE D
	
VERS COLONNE F	VERS COLONNE F
 <p style="text-align: center; color: red; font-weight: bold; font-size: small;">FOURREAU EN ATTENTE DEPUIS PARKING R-1</p>	
VERS COLONNE F	VERS COLONNE F
	
VERS COLONNE F	PIED DE COLONNE F
	
Interlocuteur XPFIbre : Fiche Etablie par :	Bastien Chapotot Date :
<i>CIRCET</i>	15/05/2023







DOSSIER TECHNIQUE IMMEUBLE AVANT PROJET DETAILLE

PHOTOS DU CHEMINEMENT DU PMI AUX PBO	
<p style="text-align: center; font-size: small;">VERS COLONNE G et H</p> 	<p style="text-align: center; font-size: small;">VERS COLONNE G et H</p> 
<p style="text-align: center; font-size: small;">VERS COLONNE G et H</p> 	<p style="text-align: center; font-size: small;">VERS COLONNE G et H</p> 
<p style="text-align: center; font-size: small;">VERS COLONNE G et H</p> 	<p style="text-align: center; font-size: small;">VERS COLONNE G</p> 
<p style="text-align: center; font-size: small;">PIED DE COLONNE G</p> 	
<p>Interlocuteur XPFBRE :</p> <p>Fiche Etablie par :</p>	<p>Bastien Chapotot</p> <p>Date : 15/05/2023</p>
<i>CIRCET</i>	<i>14 / 51</i>





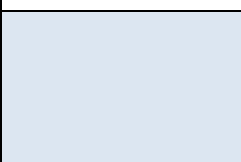

DOSSIER TECHNIQUE IMMEUBLE AVANT PROJET DETAILLE

PHOTOS DU CHEMINEMENT DU PMI AUX PBO	
VERS COLONNE F	VERS COLONNE F
	
VERS COLONNE F	VERS COLONNE F
	
VERS COLONNE F	VERS COLONNE F
	
PIED DE COLONNE G	
	
Interlocuteur XPRIBRE : Fiche Etablie par :	Bastien Chapotot Date : 15/05/2023
<i>CIRCET</i>	

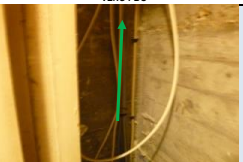
**DOSSIER TECHNIQUE IMMEUBLE
AVANT PROJET DETAILLE**

PHOTOS DU CHEMINEMENT DU BPI AUX PBO A									
<p align="center">VERS PBO</p> 	<p align="center">VERS PBO</p> 								
<p align="center">POSE PBO 01</p> 	<p align="center">VERS PBO</p> 								
<p align="center">POSE PBO 02</p> 	<p align="center">VERS PBO</p> 								
<p align="center">POSE PBO 03</p> 									
<table border="1"> <tr> <td>Interlocuteur XPFIBRE :</td> <td align="center" colspan="3">Bastien Chapotot</td> </tr> <tr> <td>Fiche Établie par :</td> <td align="center">CIRCET</td> <td>Date :</td> <td align="center">15/05/2023</td> </tr> </table>		Interlocuteur XPFIBRE :	Bastien Chapotot			Fiche Établie par :	CIRCET	Date :	15/05/2023
Interlocuteur XPFIBRE :	Bastien Chapotot								
Fiche Établie par :	CIRCET	Date :	15/05/2023						

DOSSIER TECHNIQUE IMMEUBLE
AVANT PROJET DETAILLE

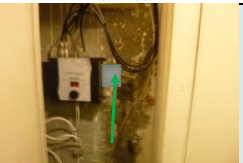
PHOTOS DU CHEMINEMENT DU PMI AUX PBO B1	
<p>VERS PBO</p> 	<p>VERS PBO</p> 
<p>VERS PBO</p> 	<p>POSE PBO 04</p> 
<p>VERS PBO</p> 	<p>POSE PBO 05</p> 
<p>VERS PBO</p> 	<p>POSE PBO 06</p> 
<p>Interlocuteur XPFIBRE :</p> <p>Fiche Établie par :</p>	<p>Bastien Chapotot</p> <p>Date : 15/05/2023</p>









DOSSIER TECHNIQUE IMMEUBLE
AVANT PROJET DETAILLE

PHOTOS DU CHEMINEMENT DU PMI AUX PBO B2									
<p>VERS PBO</p> 	<p>VERS PBO</p> 								
<p>VERS PBO</p> 	<p>POSE PBO 07</p> 								
<p>POSE PBO 08</p> 	<p>VERS PBO</p> 								
<p>POSE PBO 09</p> 									
<table border="1"> <tr> <td>Interlocuteur XPFIBRE :</td> <td colspan="3">Bastien Chapotot</td> </tr> <tr> <td>Fiche Établie par :</td> <td>CIRCET</td> <td>Date :</td> <td>15/05/2023</td> </tr> </table>		Interlocuteur XPFIBRE :	Bastien Chapotot			Fiche Établie par :	CIRCET	Date :	15/05/2023
Interlocuteur XPFIBRE :	Bastien Chapotot								
Fiche Établie par :	CIRCET	Date :	15/05/2023						

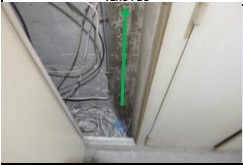
DOSSIER TECHNIQUE IMMEUBLE AVANT PROJET DETAILLE

PHOTOS DU CHEMINEMENT DU PMI AUX PBO C	
VERS PBO	VERS PBO
VERS PBO	POSE PBO 10
VERS PBO	VERS PBO
VERS PBO	POSE PBO 11
Interlocuteur XPFIBRE :	Bastien Chapotot
Fiche Établie par :	CIRCET
	Date :
	15/05/2023

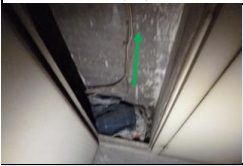





DOSSIER TECHNIQUE IMMEUBLE AVANT PROJET DETAILLE

PHOTOS DU CHEMINEMENT DU PMI AUX PBO D	
VERS PBO	VERS PBO
	
VERS PBO	POSE PBO 12
	
VERS PBO	POSE PBO 13
	
VERS PBO	POSE PBO 14
	
Interlocuteur XPFIBRE :	Bastien Chapotot
Fiche Établie par :	CIRCET
	Date : 15/05/2023

DOSSIER TECHNIQUE IMMEUBLE
AVANT PROJET DETAILLE

PHOTOS DU CHEMINEMENT DU PMI AUX PBO E	
<p>VERS PBO</p> 	<p>VERS PBO</p> 
<p>POSE PBO 15</p> 	<p>VERS PBO</p> 
<p>POSE PBO 16</p> 	<p>VERS PBO</p> 
<p>POSE PBO 17</p> 	
<p>Interlocuteur XPFIBRE : Bastien Chapotot</p> <p>Fiche Établie par : CIRCET Date : 15/05/2023</p>	







**DOSSIER TECHNIQUE IMMEUBLE
AVANT PROJET DETAILLE**

PHOTOS DU CHEMINEMENT DU PMI AUX PBO F	
VERS PBO	VERS PBO
	
VERS PBO	POSE PBO 18
	
VERS PBO	POSE PBO 19
	
VERS PBO	POSE PBO 20
	
Interlocuteur XPFIBRE :	Bastien Chapotot
Fiche Établie par :	CIRCET
Date :	15/05/2023

DOSSIER TECHNIQUE IMMEUBLE
AVANT PROJET DETAILLE

PHOTOS DU CHEMINEMENT DU PMI AUX PBO G	
	
	
	
	
Interlocuteur XPFIBRE :	Bastien Chapotot
Fiche Établie par :	CIRCET
Date :	15/05/2023

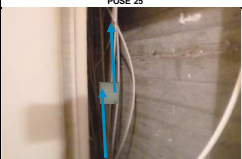
DOSSIER TECHNIQUE IMMEUBLE AVANT PROJET DETAILLE

PHOTOS DU CHEMINEMENT DU PMI AUX PBO H	
VERS PBO	VERS PBO
	
VERS PBO	POSE PBO 24
	
VERS PBO	POSE PBO 25
	
VERS PBO	POSE PBO 26
	
Interlocuteur XPFIBRE :	Bastien Chapotot
Fiche Établie par :	CIRCET
	Date : 15/05/2023

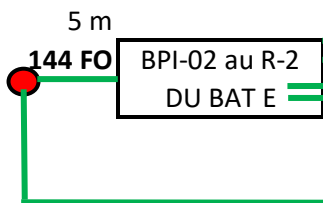

BATIMENT D

TOTAL	16
R+3	4
R+2	4
R+1	2
R+1	2
RDC	4



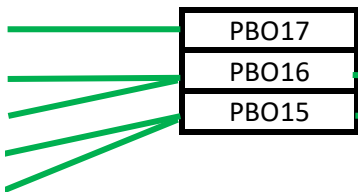

260m

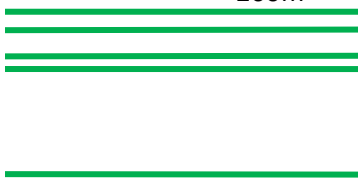

BATIMENT A

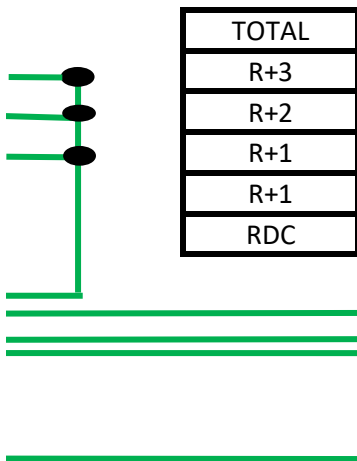

17	
4	—————
4	—————
2	—————
2	—————
4+1P	—————

—————
—————
—————

—————

144 FO

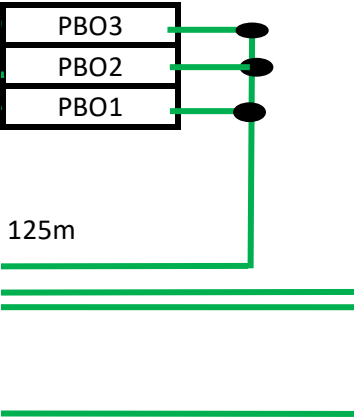

BATIMENT B1

TOTAL	16
R+3	4
R+2	4
R+1	2
R+1	2
RDC	4



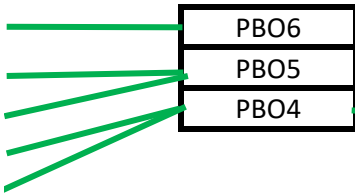

195m



BATIMENT B2

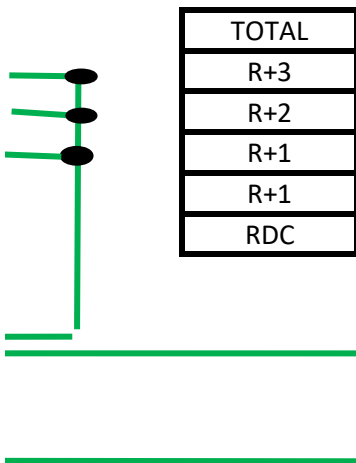

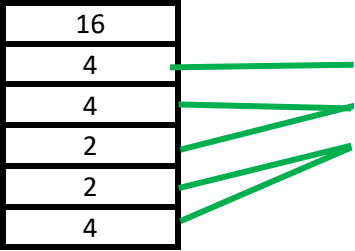

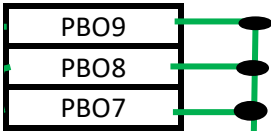

225m



BATIMENT E

TOTAL	16
R+3	4
R+2	4
R+1	2
R+1	2
RDC	4

BPI-01 au R-2
DU BAT E



5m

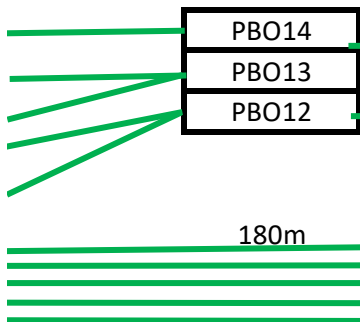

BATIMENT C

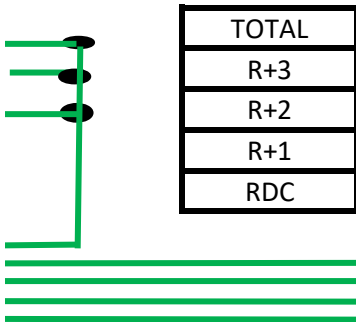

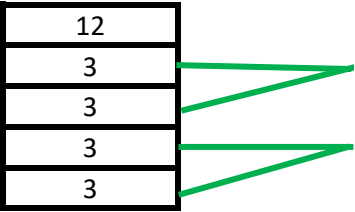

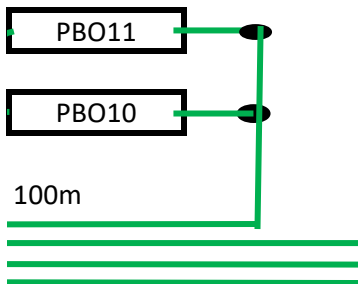

BATIMENT F

TOTAL	16
R+3	4
R+2	4
R+1	2
R+1	2
RDC	4



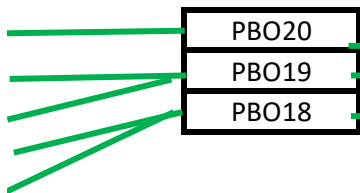

BATIMENT G

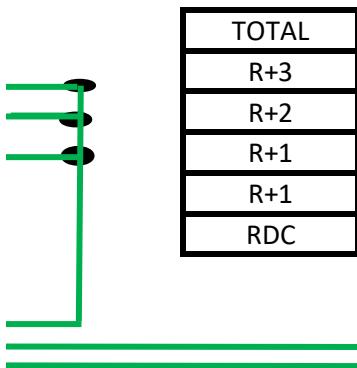

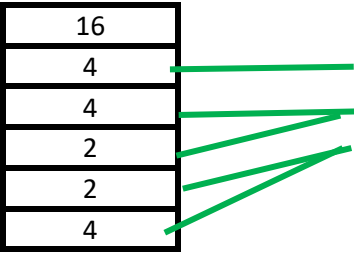

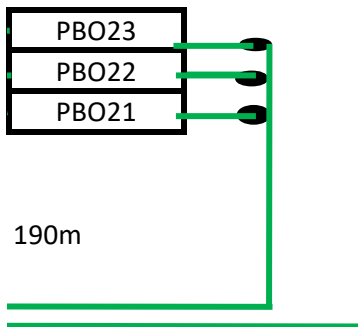

BATIMENT H

TOTAL	16
R+3	4
R+2	4
R+1	2
R+1	2
RDC	4

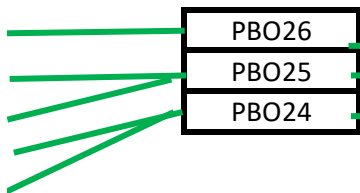

220m



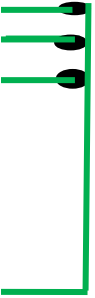

PLAN DE CABLAGE

