

RESEAU TRES HAUT DEBIT EN FIBRE OPTIQUE - DOSSIER TECHNIQUE FTTH

Renseignement Immeuble

Gestionnaire :	CABINET ORALIA MOREL Mme Roux Emmanuelle 75009 PARIS	Téléphone : 01 45 26 87 46 E-mail : marie-emmanuelle.roux@oralia-morel.fr
	M gaspar 18 BOULEVARD DE LA REPUBLIQUE 92420 VAUCRESSON	Téléphone : 01 47 41 49 21 Mobile : 06 84 92 67 07 E-mail : Digicode :

Renseignement dossier technique

Prestataire	Visite immeuble	Réalisation dossier technique	Correspondant technique
	Date : 22/02/2012 Intervenant : CIRCET	Date : 09-04-2012 Rédacteur : MDA	

Validation APD

Nom : _____ Date : _____
Qualité : _____ Signature : _____

Référence	Indice	Document	Date
DT-APD-92008004	1.0	Avant Projet Détaillé (APD)	10/04/2012
Réf. convention : 146810		Convention FTTH	

Sommaire

Renseignement Immeuble	p. 2
Sommaire	p. 3
1 - Introduction	p. 4
2 - Situation Géographique	p. 5
3 - Plan de casage	p. 6
4 - PMI (92008004)	p. 7
5 - Colonne Montante 1	p. 28
6 - Colonne Montante 2	p. 32
7 - Colonne Montante 3	p. 36
8 - Colonne Montante 4	p. 40
9 - Colonne Montante 5	p. 44
10 - Colonne Montante 6	p. 49
11 - Colonne Montante 7	p. 53
12 - Colonne Montante 8	p. 58
13 - Colonne Montante 9	p. 63
14 - Branchement des abonnés	p. 68

Référence	Indice	Document	Date
DT-APD-92008004	1.0	Avant Projet Détaillé (APD)	10/04/2012
Réf. convention : 146810		Convention FTTH	

1 - Introduction

Le schéma ci-dessus illustre les principes de déploiement de la fibre optique dans un immeuble.

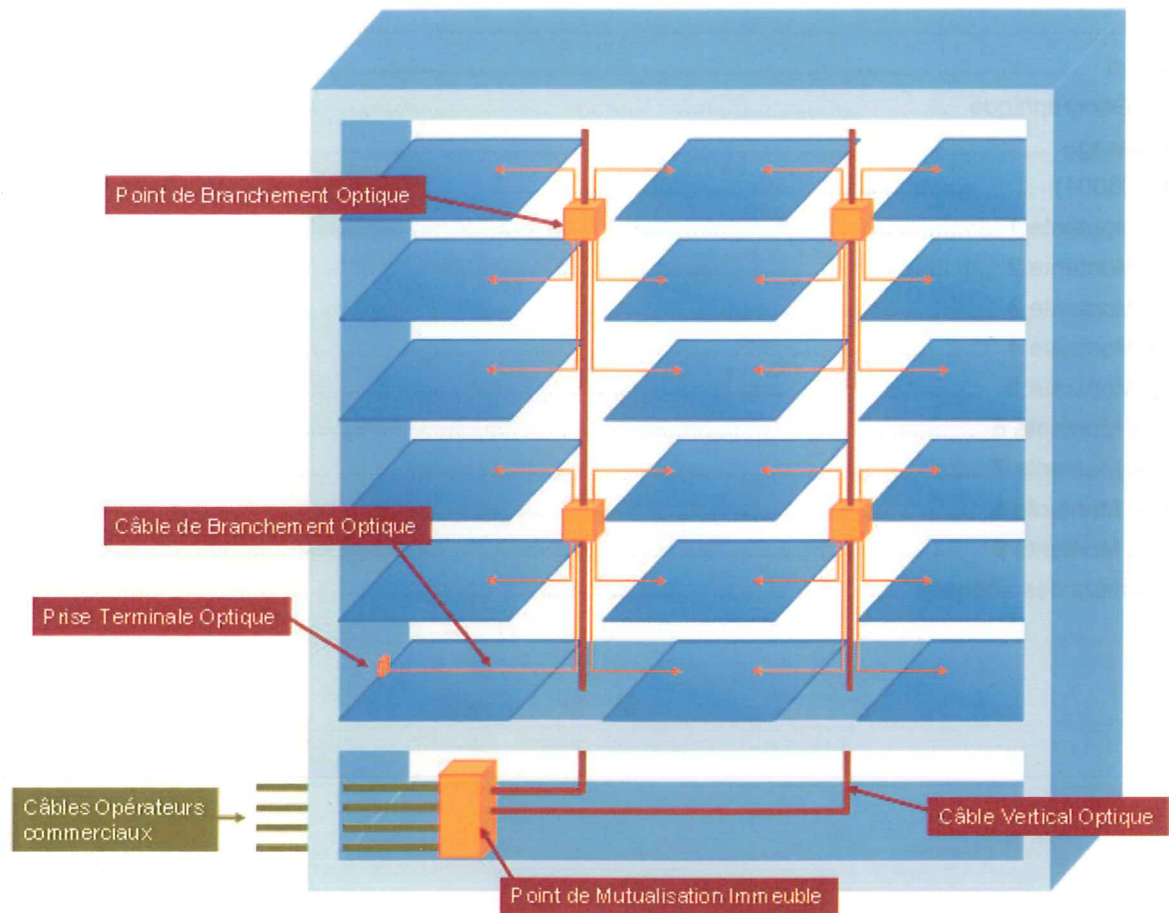

Un minimum de 4 opérateurs commercialisant des services à très haut débits peuvent se raccorder au boîtier installé au Point de mutualisation immeuble (PMI) en amenant leurs câbles optiques en provenance de l'infrastructure génie civil extérieure.

Depuis le boîtier de mutualisation immeuble, des câbles verticaux optiques sont déployés pour former des colonnes montantes optiques desservant des boîtiers de branchement optique.

Des câbles de branchement optique sont finalement déployés pour relier les boîtiers de branchement aux prises terminales optiques permettant aux opérateurs commerciaux de délivrer des services à très haut débit.

2 - Situation Géographique

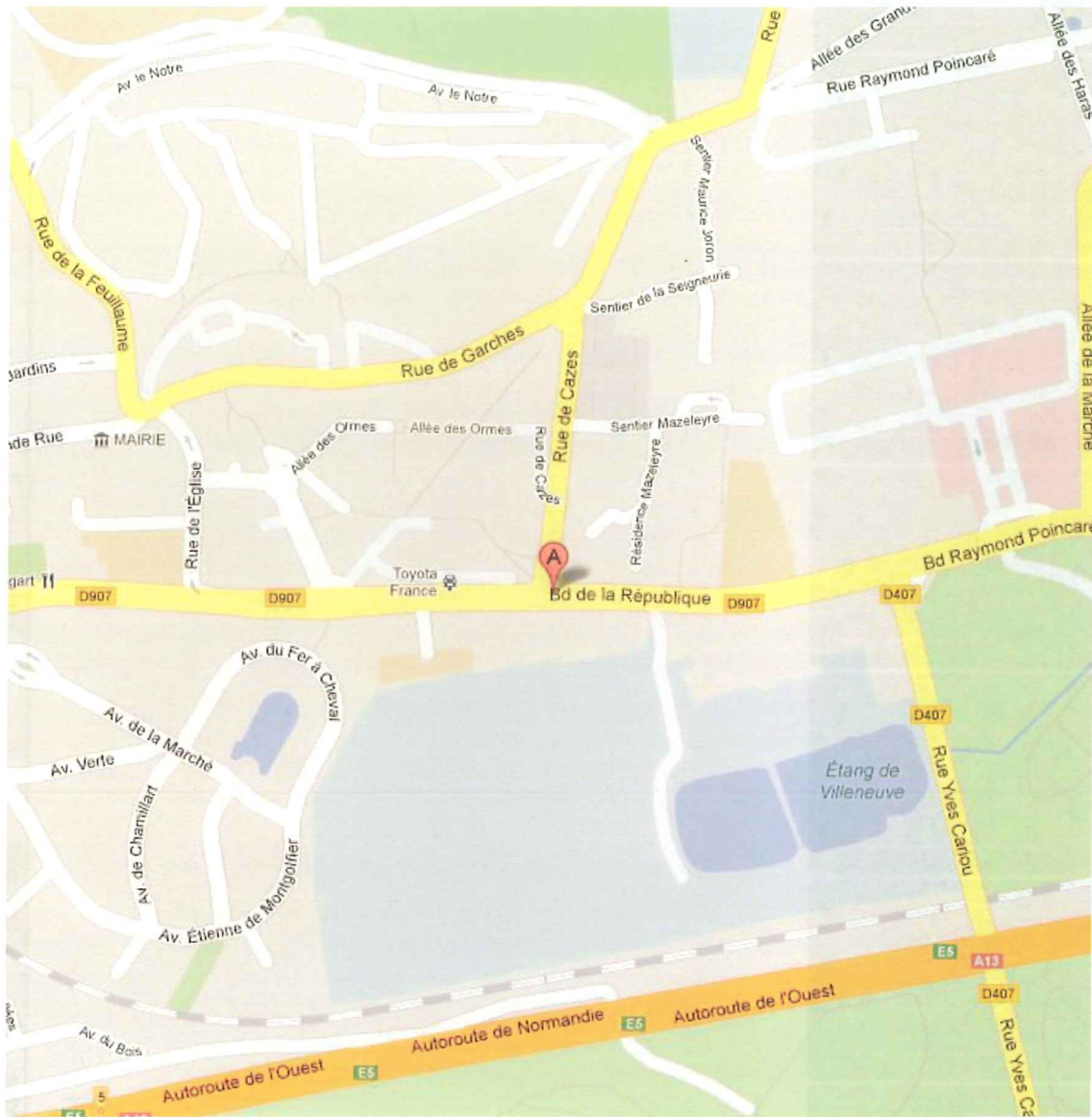

PLAN DE VILLE



8329_FACADE



8330_facade

Référence	Indice	Document	Date
DT-APD-92008004	1.0	Avant Projet Détaillé (APD)	10/04/2012
Réf. convention : 146810		Convention FTTH	

3 - Plan de casage

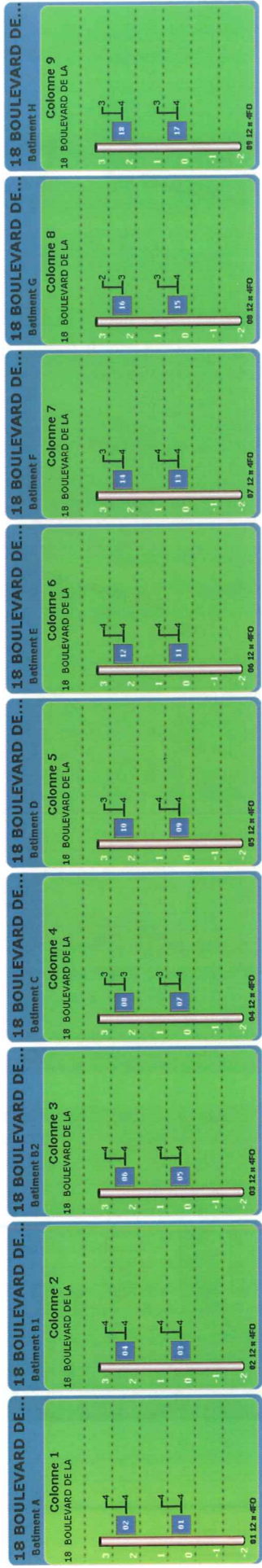

Référence	Indice	Document	Date
DT-APD-92008004	1.0	Avant Projet Détaillé (APD)	10/04/2012
Réf. convention		Convention FTTH	

4 - Point de mutualisation immeuble (92008004)

Lieu d'installation du PMI	
Etage :	-2
Emplacement :	Autre

Câblage PMI vers les étages supérieurs	
Type PMI	Idea Optical
Type de remonté	Gaine technique
Mode de pose H	Chemin de cable
Inter-palier	Fourreau existant

Adduction immeubles					
Type	Niveau	Nb alvéoles existantes	Nb alvéoles libres ou % d'occupation	Distance adduction - PMI	Mode de pose H
Penetration GC	-2	1	0.4	18	Chemin de cable

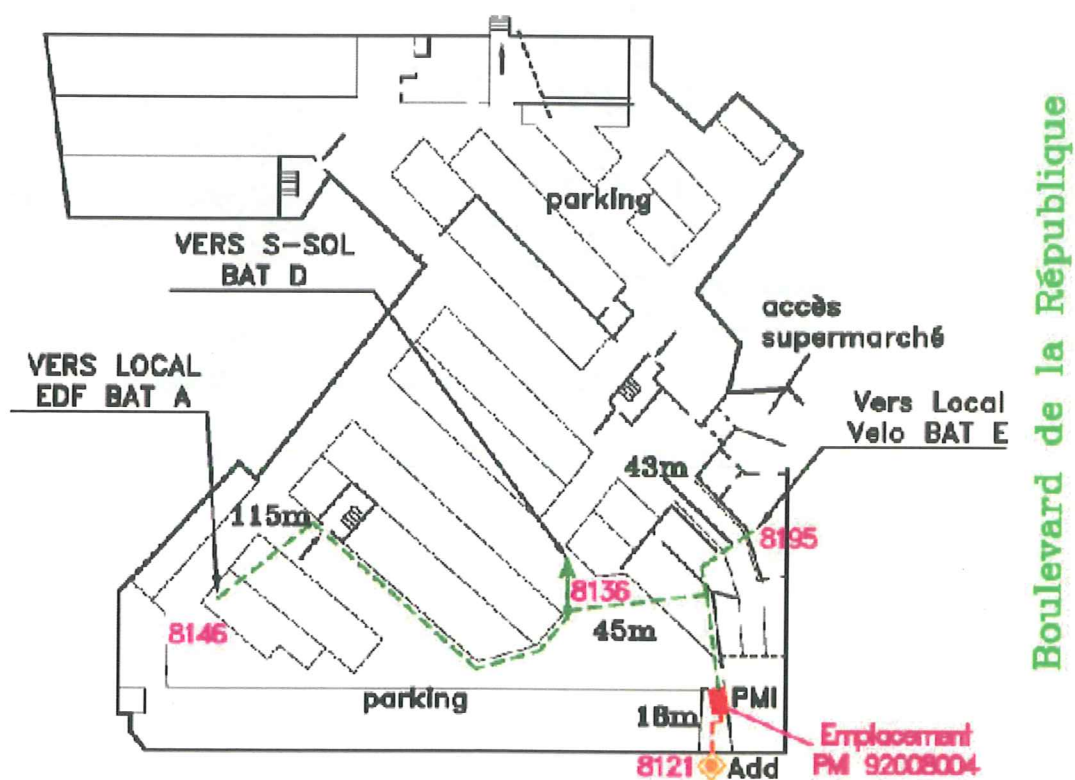

SOUS SOL-2 (SUPER U)

SSOL

plan

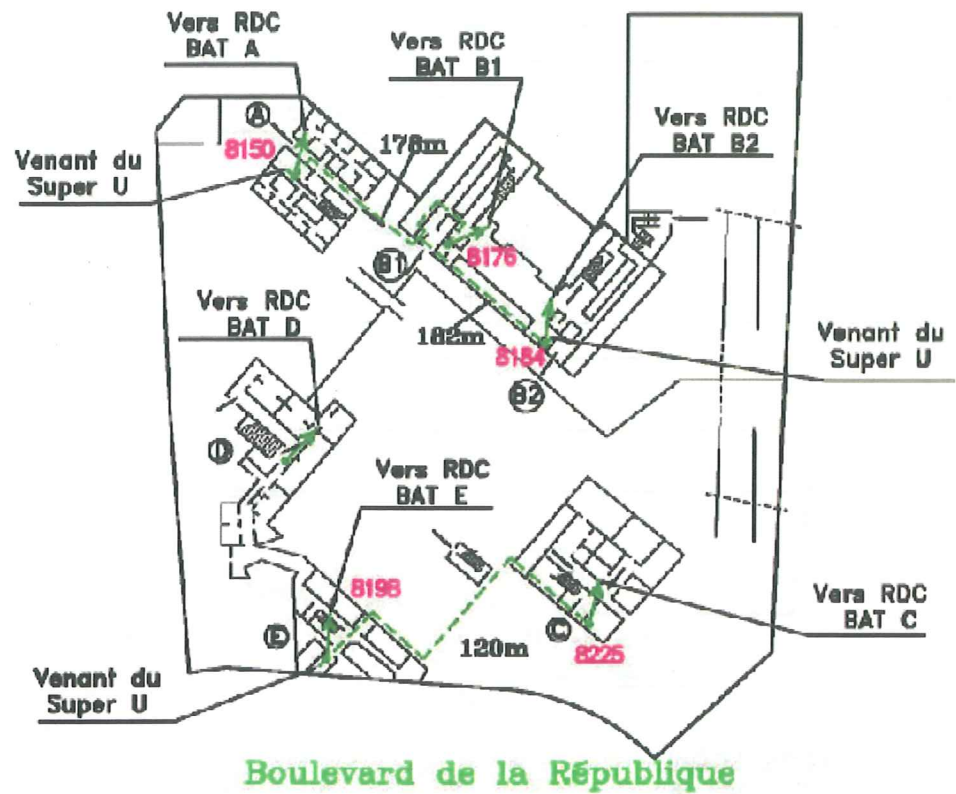

Sous-Sol A-B1-B2-C-D et E

SSOL

Référence	Indice	Document	Date
DT-APD-92008004	1.0	Avant Projet Détaillé (APD)	10/04/2012
Réf. convention : 146810		Convention FTTH	

plan

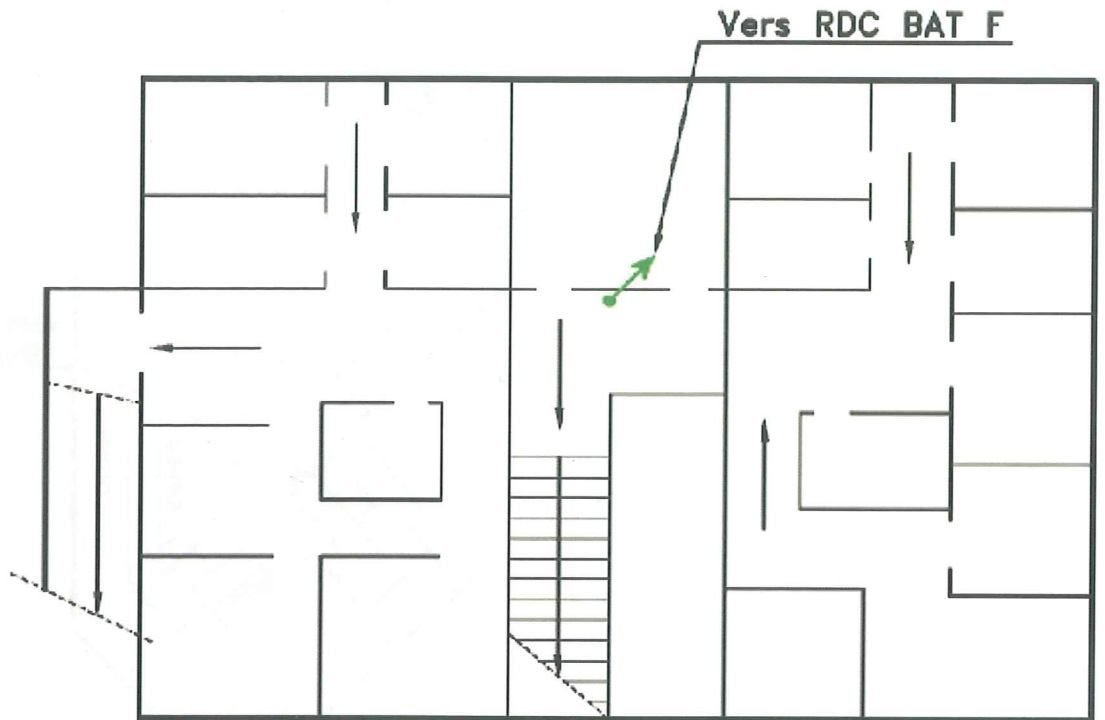

Sous-Sol BAT F

SSOL

Référence	Indice	Document	Date
DT-APD-92008004	1.0	Avant Projet Détaillé (APD)	10/04/2012
Réf. convention : 146810		Convention FTTH	

plan

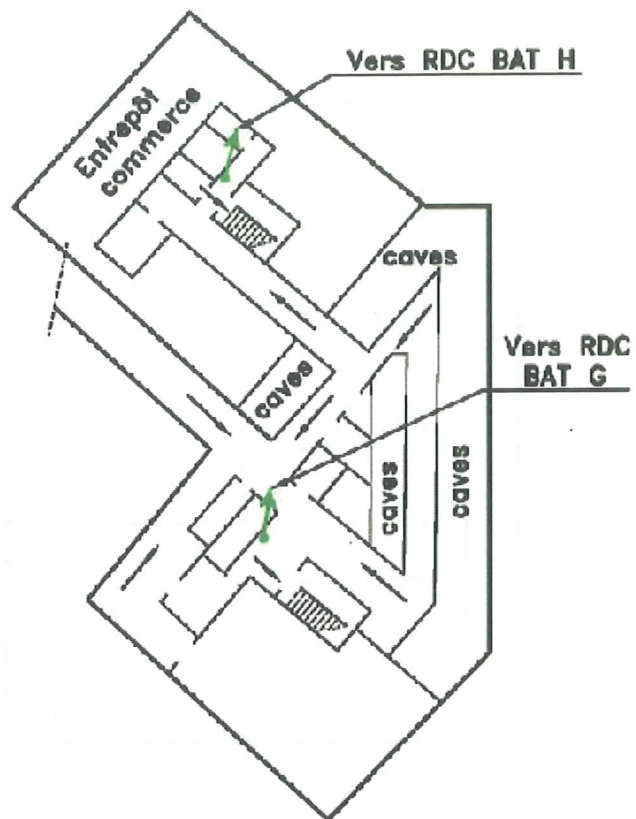

Sous-Sol BAT G et H

SSOL

Référence	Indice	Document	Date
DT-APD-92008004	1.0	Avant Projet Détaillé (APD)	10/04/2012
Réf. convention : 146810		Convention FTTH	

photo



8121_ADDUCTION

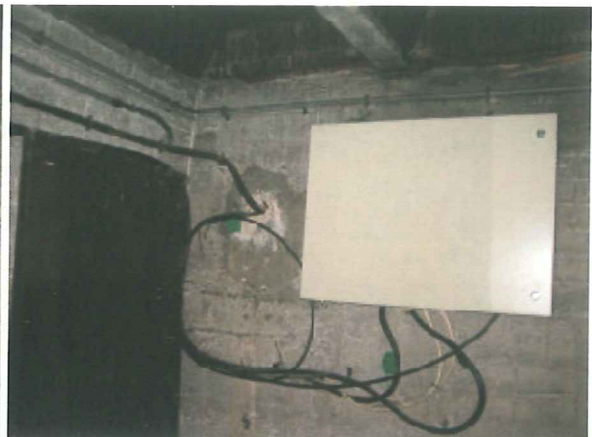

8122_ADDUCTION VERS PMI



8123_ADDUCTION VERS PMI

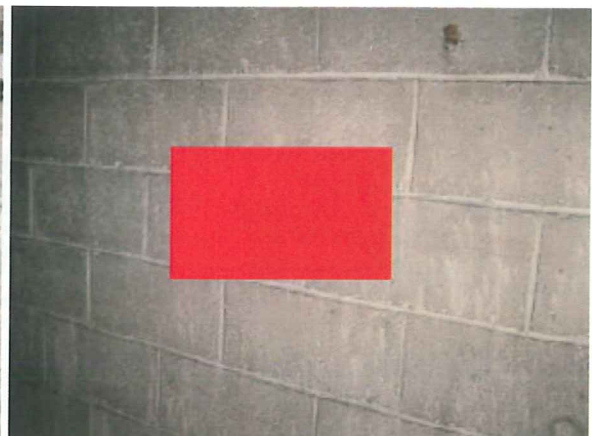

8124_EMPLACEMENT PMI



8125_PMI VERS PDC D

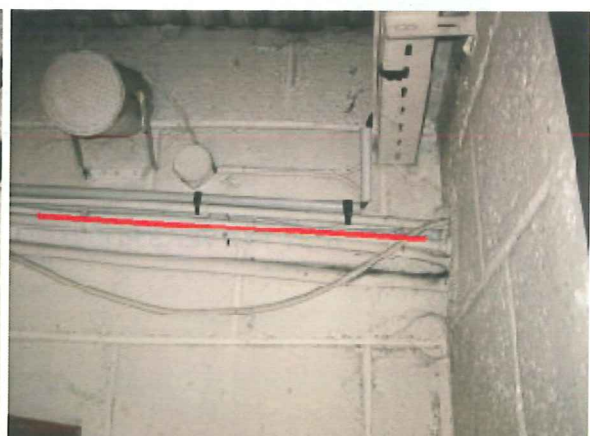

8126_PMI VERS PDC D

Référence	Indice	Document	Date
DT-APD-92008004	1.0	Avant Projet Détaillé (APD)	10/04/2012
Réf. convention : 146810		Convention FTTH	

photo



8127_PMI VERS PDC D

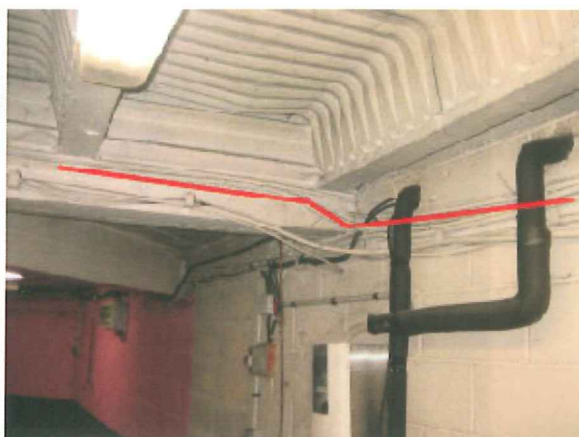

8128_PMI VERS PDC D



8129_PMI VERS PDC D



8130_PMI VERS PDC D



8131_PMI VERS PDC D



8132_PMI VERS PDC D

Référence	Indice	Document	Date
DT-APD-92008004	1.0	Avant Projet Détaillé (APD)	10/04/2012
Réf. convention : 146810		Convention FTTH	

photo



8133_PMI VERS PDC D

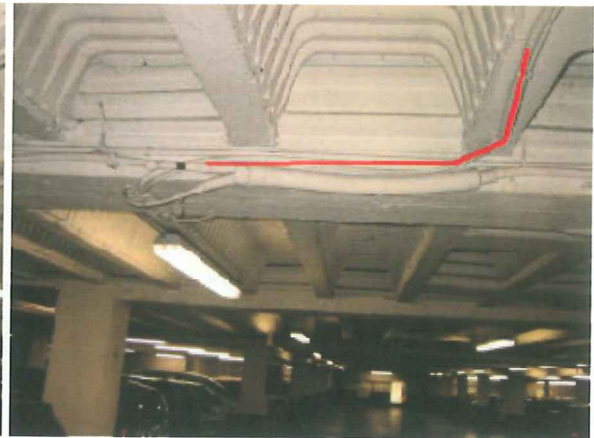

8134_PMI VERS PDC D



8135_PMI VERS PDC D

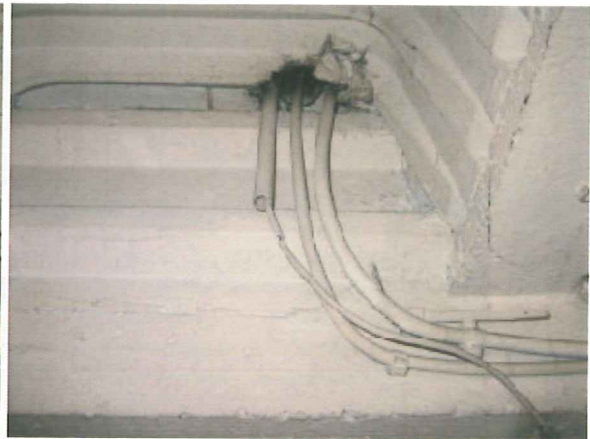

8136_PDC D

Batiment D Point de remontee en fourreau

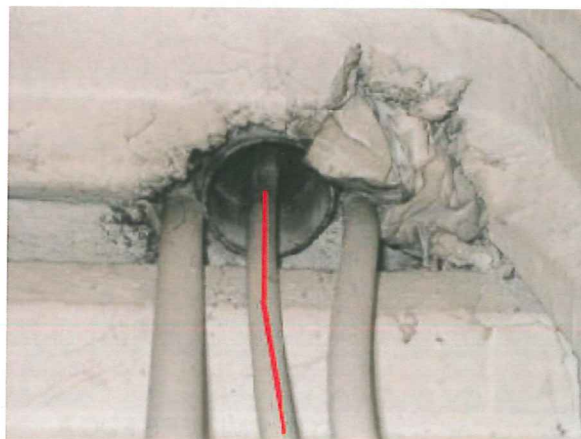

8137_PMI VERS PDC A



8138_PMI VERS PDC A

Référence	Indice	Document	Date
DT-APD-92008004	1.0	Avant Projet Détaillé (APD)	10/04/2012
Réf. convention : 146810		Convention FTTH	

photo



8139_PMI VERS PDC A



8140_PMI VERS PDC A



8141_PMI VERS PDC A

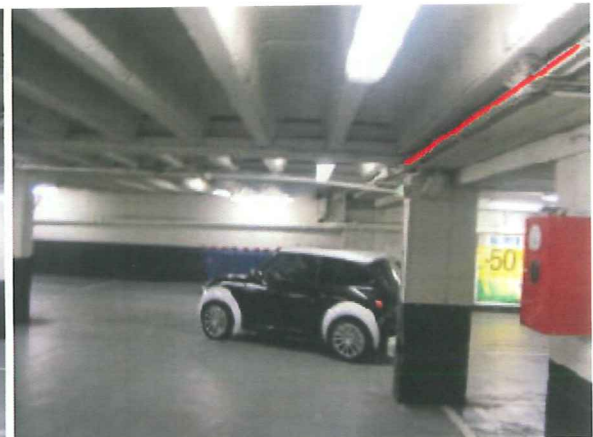

8142_PMI VERS PDC A



8143_PMI VERS PDC A



8144_PMI VERS PDC A

Référence	Indice	Document	Date
DT-APD-92008004	1.0	Avant Projet Détaillé (APD)	10/04/2012
Réf. convention : 146810		Convention FTTH	

photo



8145_PMI VERS PDC A



8146_PMI VERS PDC A



8147_PMI VERS PDC A



8148_PMI VERS PDC A

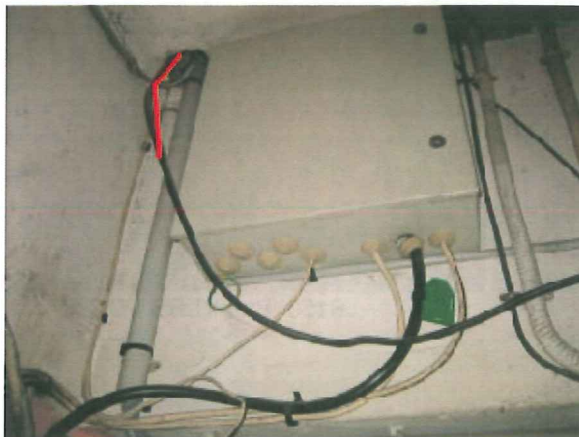

8149_PMI VERS PDC A



8150_PDC A
Batiment A Point de remontee en fourreau

Référence	Indice	Document	Date
DT-APD-92008004	1.0	Avant Projet Détaillé (APD)	10/04/2012
Réf. convention : 146810		Convention FTTH	

photo

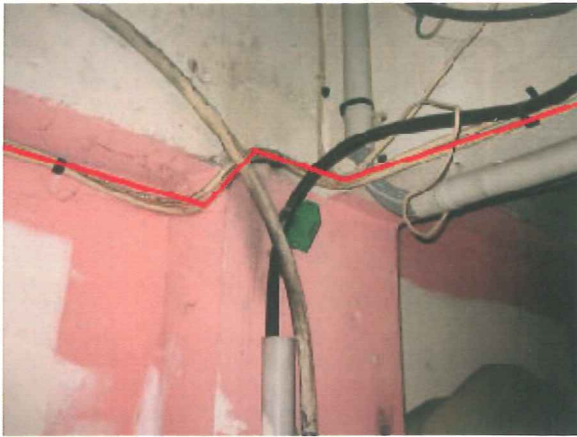

8151_PMI VERS PDC B1

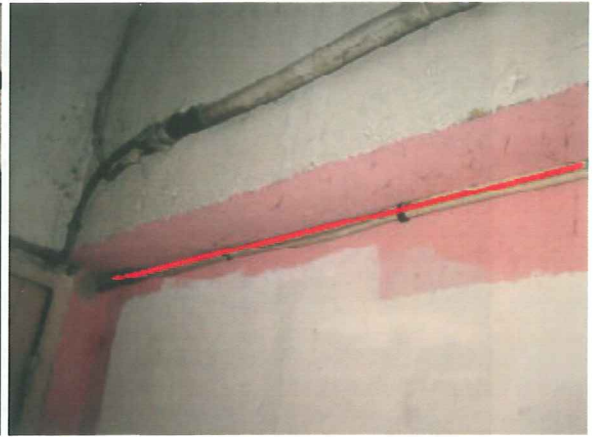

8152_PMI VERS PDC B1



8153_PMI VERS PDC B1



8154_PMI VERS PDC B1



8155_PMI VERS PDC B1

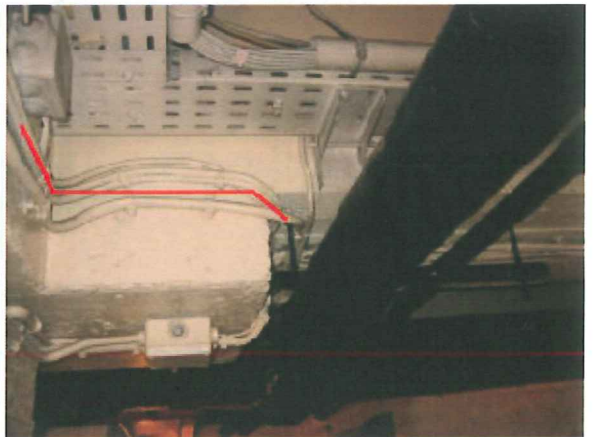

8156_PMI VERS PDC B1

Référence	Indice	Document	Date
DT-APD-92008004	1.0	Avant Projet Détaillé (APD)	10/04/2012
Réf. convention : 146810		Convention FTTH	

photo



8157_PMI VERS PDC B1



8158_PMI VERS PDC B1



8160_PMI VERS PDC B1



8161_PMI VERS PDC B1



8162_PMI VERS PDC B1



8163_PMI VERS PDC B1

Référence	Indice	Document	Date
DT-APD-92008004	1.0	Avant Projet Détaillé (APD)	10/04/2012
Réf. convention : 146810		Convention FTTH	

photo



8164_PMI VERS PDC B1



8165_PMI VERS PDC B1



8166_PMI VERS PDC B1



8167_PMI VERS PDC B1



8168_PMI VERS PDC B1



8169_PMI VERS PDC B1

Référence	Indice	Document	Date	
DT-APD-92008004	1.0	Avant Projet Détaillé (APD)	10/04/2012	
Réf. convention : 146810		Convention FTTH		18/79

photo

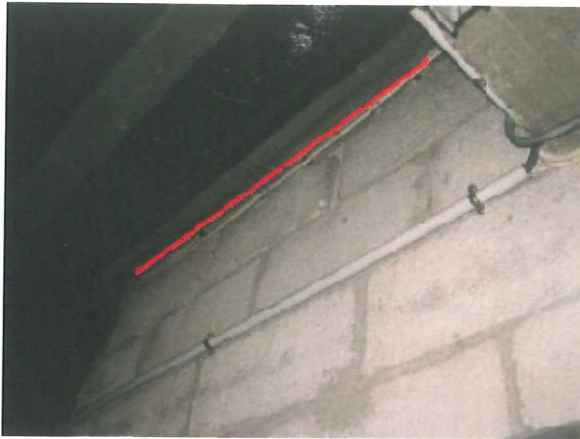

8170_PMI VERS PDC B1



8171_PMI VERS PDC B1



8172_PMI VERS PDC B1



8173_PMI VERS PDC B1



8174_PMI VERS PDC B1



8175_PMI VERS PDC B1

Référence	Indice	Document	Date
DT-APD-92008004	1.0	Avant Projet Détaillé (APD)	10/04/2012
Réf. convention : 146810		Convention FTTH	

photo



8176_PDC B1

Batiment B1 Point de remontee en fourreau

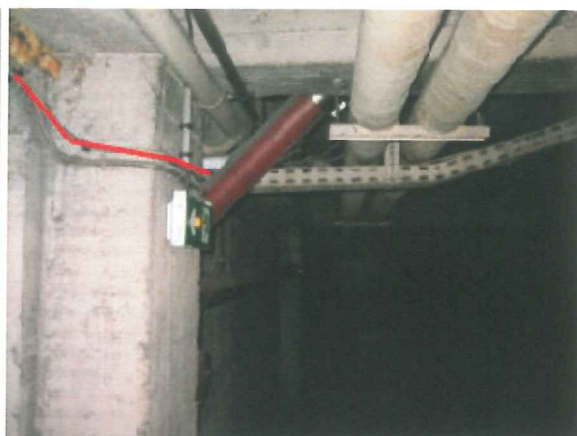

8177_PMI VERS PDC B2



8178_PMI VERS PDC B2



8179_PMI VERS PDC B2



8180_PMI VERS PDC B2



8181_PMI VERS PDC B2

Référence	Indice	Document	Date
DT-APD-92008004	1.0	Avant Projet Détaillé (APD)	10/04/2012
Réf. convention : 146810		Convention FTTH	

photo



8182_PMI VERS PDC B2



8183_PMI VERS PDC B2



8184_PDC B2

Batiment B2 Point de remontee en fourreau



8185_PMI VERS PDC E



8186_PMI VERS PDC E

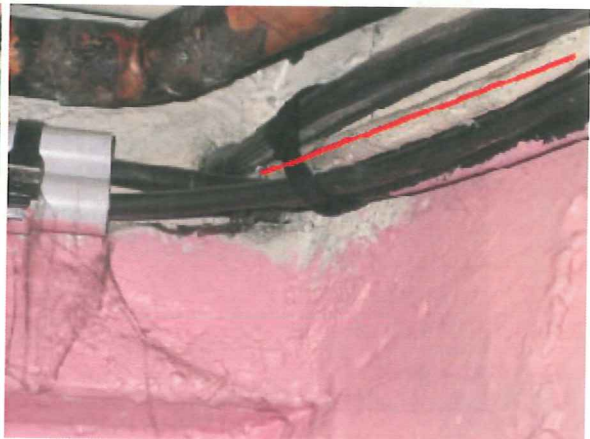

8187_PMI VERS PDC E

Référence	Indice	Document	Date
DT-APD-92008004	1.0	Avant Projet Détaillé (APD)	10/04/2012
Réf. convention : 146810		Convention FTTH	

photo

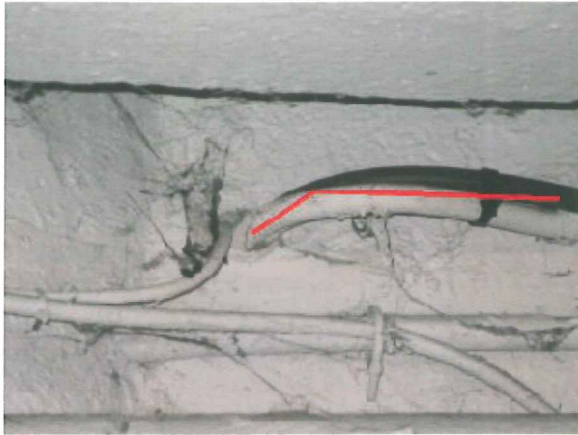

8188_PMI VERS PDC E



8189_PMI VERS PDC E



8190_PMI VERS PDC E

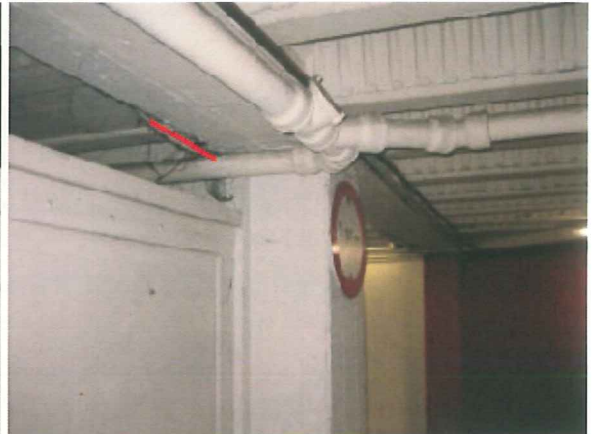

8191_PMI VERS PDC E



8192_PMI VERS PDC E



8193_PMI VERS PDC E

Référence	Indice	Document	Date
DT-APD-92008004	1.0	Avant Projet Détaillé (APD)	10/04/2012
Réf. convention : 146810		Convention FTTH	

photo



8194_PMI VERS PDC E



8195_PMI VERS PDC E



8196_PMI VERS PDC E

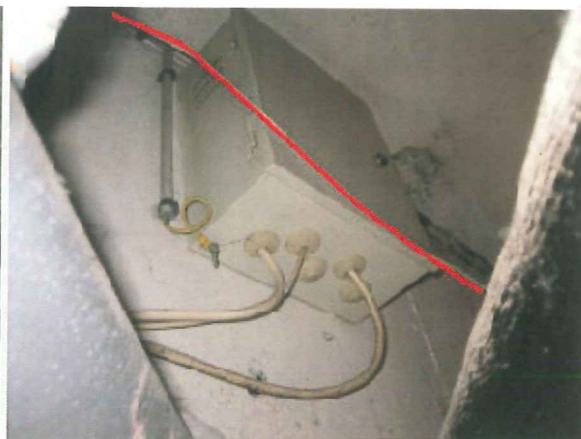

8197_PMI VERS PDC E



8198_PDC E

Batiment E Point de remontee en fourreau



8199_PMI VERS PDC C

Référence	Indice	Document	Date
DT-APD-92008004	1.0	Avant Projet Détaillé (APD)	10/04/2012
Réf. convention : 146810		Convention FTTH	

photo

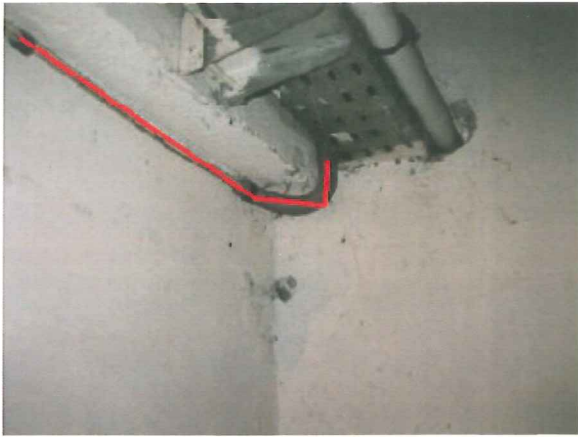

8200_PMI VERS PDC C

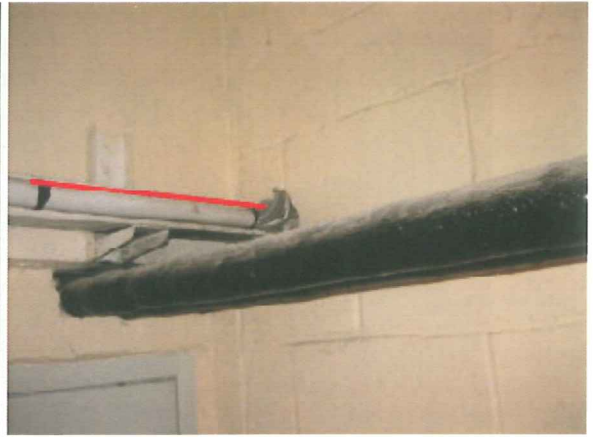

8201_PMI VERS PDC C



8202_PMI VERS PDC C

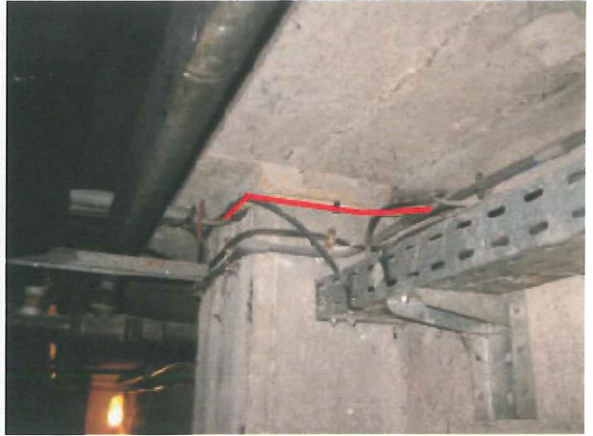

8203_PMI VERS PDC C



8204_PMI VERS PDC C



8205_PMI VERS PDC C

Référence	Indice	Document	Date
DT-APD-92008004	1.0	Avant Projet Détaillé (APD)	10/04/2012
Réf. convention : 146810		Convention FTTH	

photo

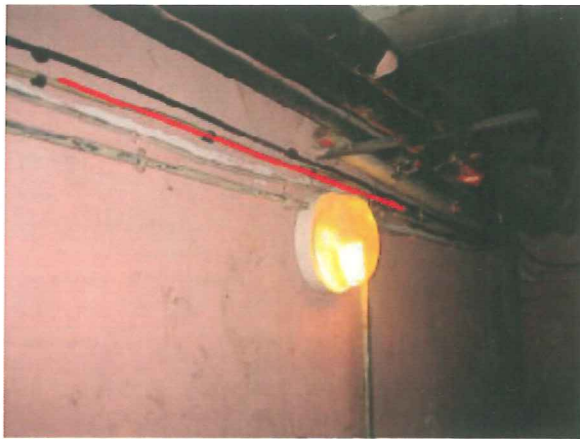

8207_PMI VERS PDC C

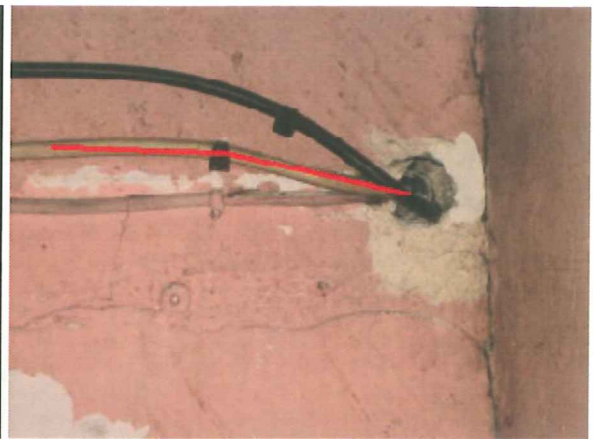

8208_PMI VERS PDC C



8209_PMI VERS PDC C



8210_PMI VERS PDC C

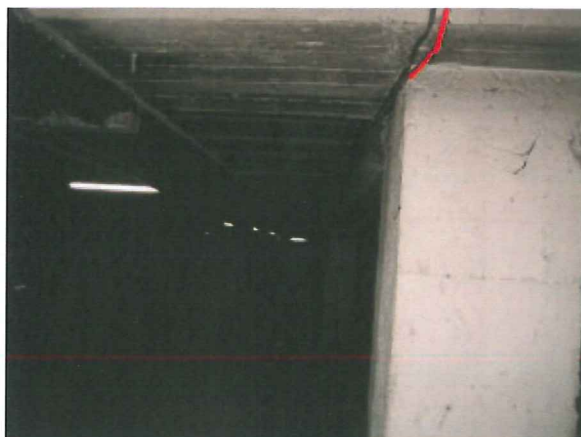

8211_PMI VERS PDC C



8212_PMI VERS PDC C

Référence	Indice	Document	Date
DT-APD-92008004	1.0	Avant Projet Détaillé (APD)	10/04/2012
Réf. convention : 146810		Convention FTTH	

photo



8213_PMI VERS PDC C



8214_PMI VERS PDC C



8215_PMI VERS PDC C

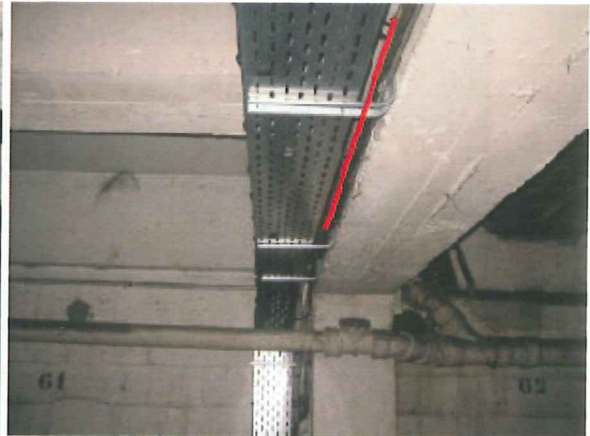

8216_PMI VERS PDC C



8217_PMI VERS PDC C

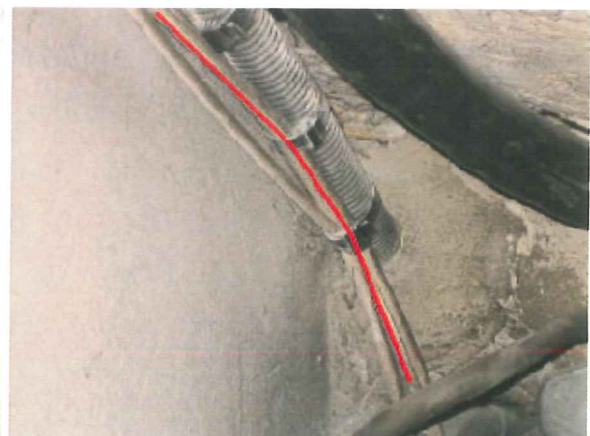

8218_PMI VERS PDC C

Référence	Indice	Document	Date
DT-APD-92008004	1.0	Avant Projet Détaillé (APD)	10/04/2012
Réf. convention : 146810		Convention FTTH	

photo



8219_PMI VERS PDC C

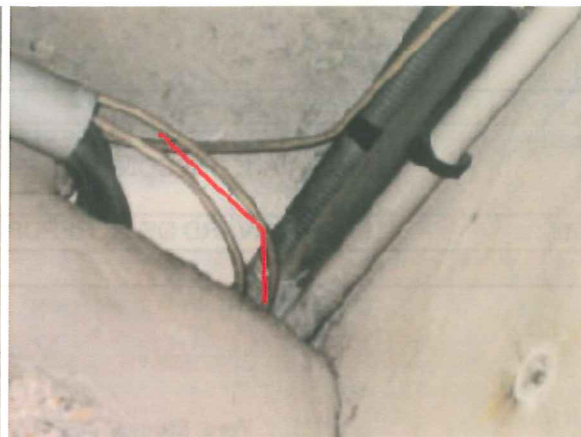

8220_PMI VERS PDC C



8221_PMI VERS PDC C

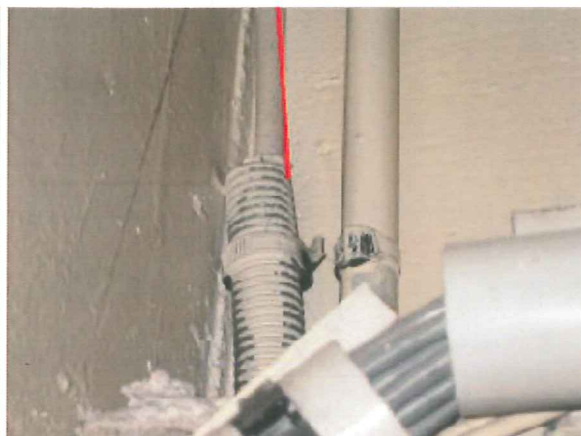

8222_PMI VERS PDC C



8224_PMI VERS PDC C



8225_PDC C
Batiment C Point de remontee en fourreau

Référence	Indice	Document	Date
DT-APD-92008004	1.0	Avant Projet Détaillé (APD)	10/04/2012
Réf. convention : 146810		Convention FTTH	

5 - Colonne Montante 1

Lieu de la colonne	
Adresse(s) :	18 BOULEVARD DE LA REPUBLIQUE 92420 VAUCRESSON
Batiment :	18 BOULEVARD DE LA REPUBLIQUE
Étage :	0

Câblage vertical	
Type de remonté	Gaine technique
Mode de pose H	Fourreau
Inter-palier	Fourreau existant

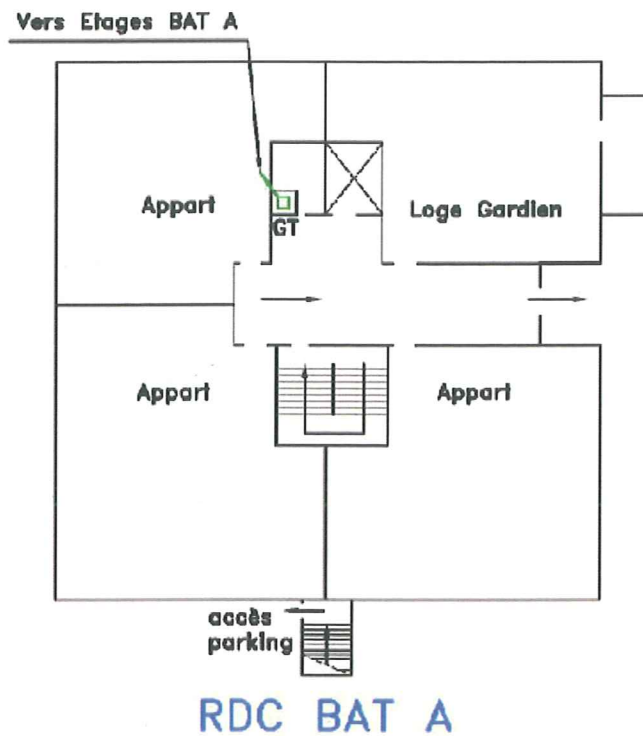

Référence	Indice	Document	Date
DT-APD-92008004	1.0	Avant Projet Détaillé (APD)	10/04/2012
Réf. convention : 146810		Convention FTTH	

Lieu de la colonne	
Adresse(s) :	18 BOULEVARD DE LA REPUBLIQUE 92420 VAUCRESSON
Batiment :	18 BOULEVARD DE LA REPUBLIQUE
Etage :	1 3

Câblage vertical	
Type de remonté	Gaine technique
Mode de pose H	Fourreau
Inter-palier	Fourreau existant

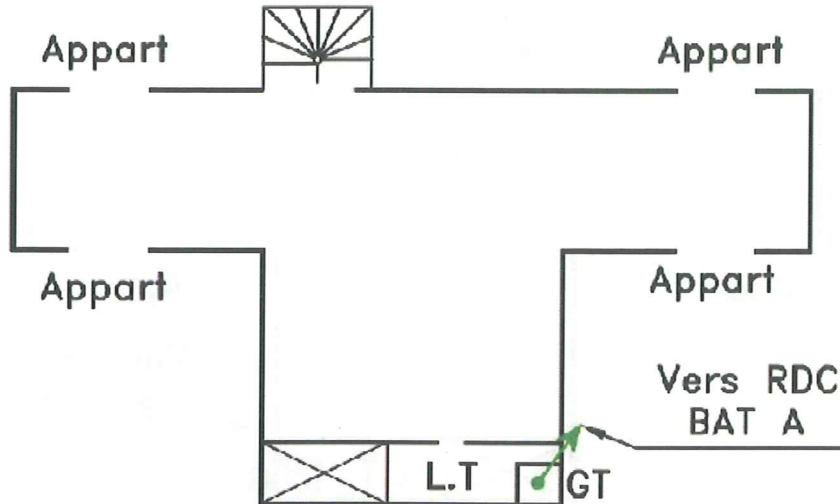

1er et 3ème étage
BAT A

Référence	Indice	Document	Date
DT-APD-92008004	1.0	Avant Projet Détaillé (APD)	10/04/2012
Réf. convention : 146810		Convention FTTH	

Lieu de la colonne	
Adresse(s) :	18 BOULEVARD DE LA REPUBLIQUE 92420 VAUCRESSON
Batiment :	18 BOULEVARD DE LA REPUBLIQUE
Étage :	2

Câblage vertical	
Type de remonté	Gaine technique
Mode de pose H	Fourreau
Inter-palier	Fourreau existant

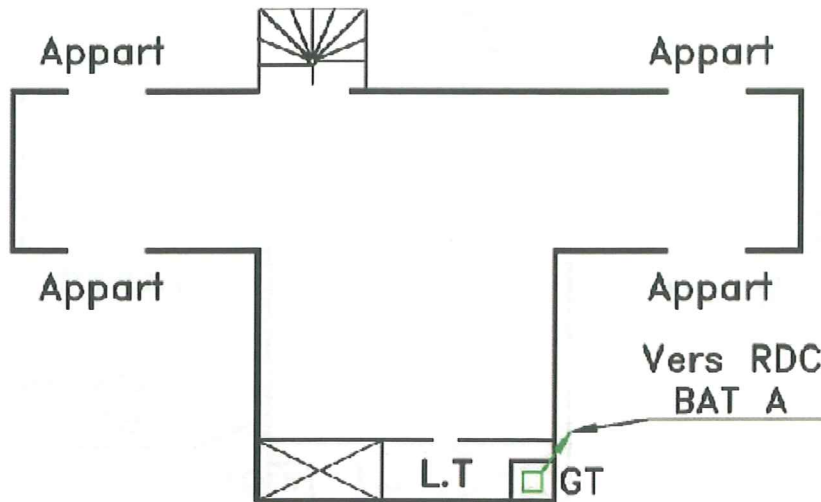

2ème étage BAT A

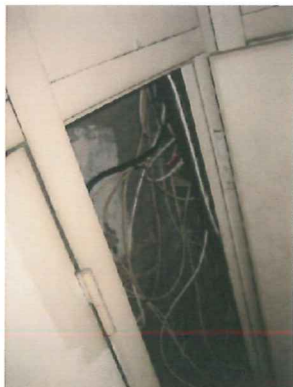

8317_GAINE TECHNIQUE
Batiment A

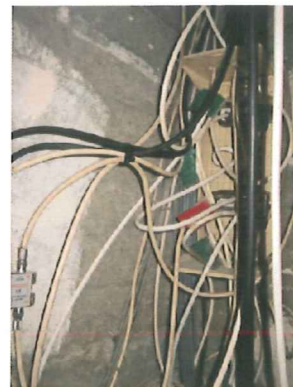

8318_GAINE TECHNIQUE
Batiment A

Référence	Indice	Document	Date
DT-APD-92008004	1.0	Avant Projet Détaillé (APD)	10/04/2012
Réf. convention : 146810		Convention FTTH	

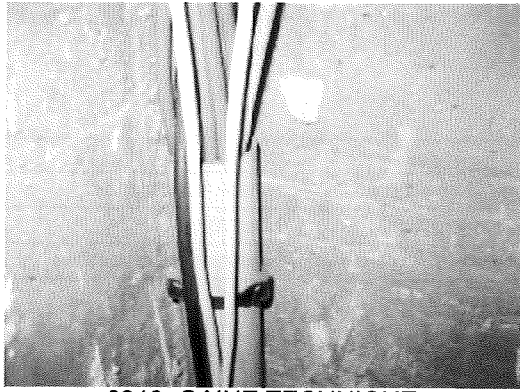

8319_GAINE TECHNIQUE
Batiment A

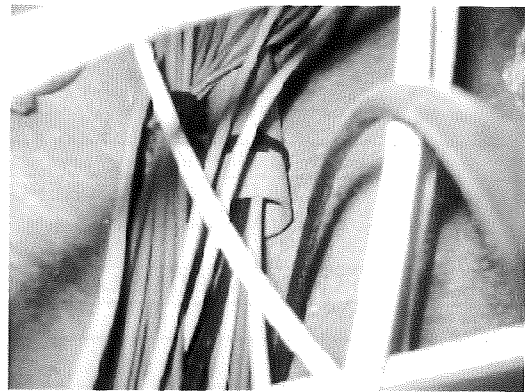

8320_GAINE TECHNIQUE
Batiment A

Référence	Indice	Document	Date
DT-APD-92008004	1.0	Avant Projet Détaillé (APD)	10/04/2012
Réf. convention : 146810		Convention FTTH	

6 - Colonne Montante 2

Lieu de la colonne	
Adresse(s) :	18 BOULEVARD DE LA REPUBLIQUE 92420 VAUCRESSON
Batiment :	18 BOULEVARD DE LA REPUBLIQUE
Étage :	0

Câblage vertical	
Type de remonté	Gaine technique
Mode de pose H	Fourreau
Inter-palier	Fourreau existant

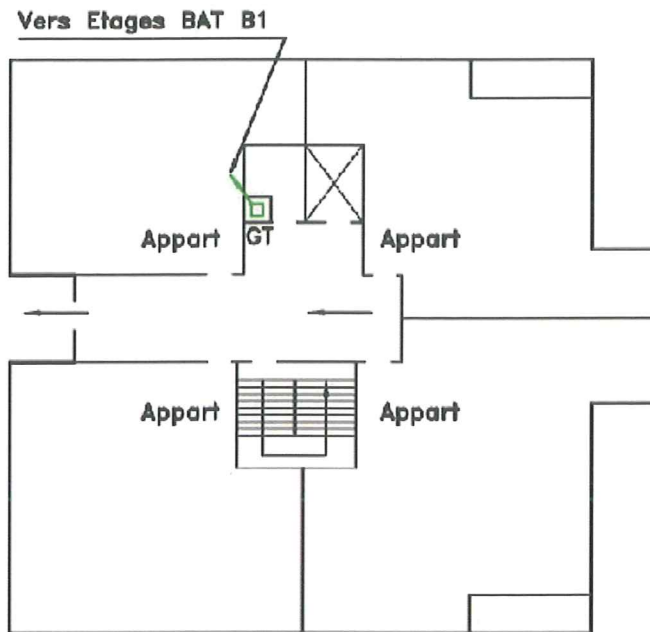

RDC BAT B1

Référence	Indice	Document	Date
DT-APD-92008004	1.0	Avant Projet Détaillé (APD)	10/04/2012
Réf. convention : 146810		Convention FTTH	

Lieu de la colonne	
Adresse(s) :	18 BOULEVARD DE LA REPUBLIQUE 92420 VAUCRESSON
Batiment :	18 BOULEVARD DE LA REPUBLIQUE
Etage :	1 3

Câblage vertical	
Type de remonté	Gaine technique
Mode de pose H	Fourreau
Inter-palier	Fourreau existant

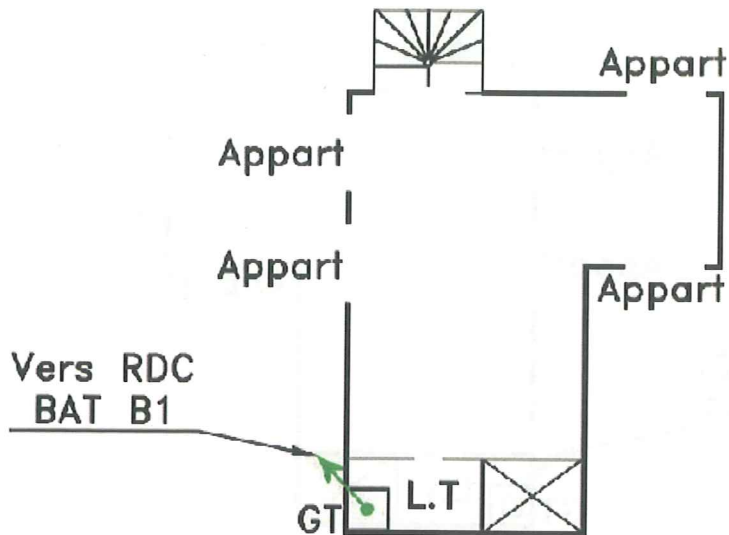

1er et 3ème étage
BAT B1

Référence	Indice	Document	Date
DT-APD-92008004	1.0	Avant Projet Détaillé (APD)	10/04/2012
Réf. convention : 146810		Convention FTTH	

Lieu de la colonne	
Adresse(s) :	18 BOULEVARD DE LA REPUBLIQUE 92420 VAUCRESSON
Batiment :	18 BOULEVARD DE LA REPUBLIQUE
Étage :	2

Câblage vertical	
Type de remonté	Gaine technique
Mode de pose H	Fourreau
Inter-palier	Fourreau existant

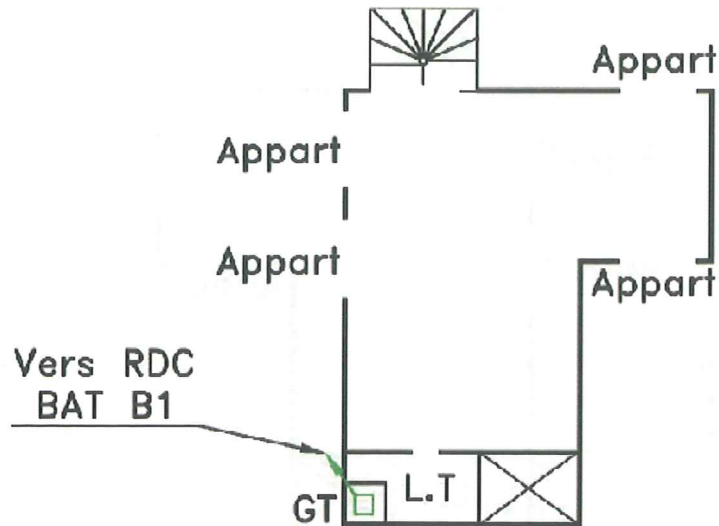

2ème étage BAT B1



8307_GAINE TECHNIQUE
Batiment B1



8308_GAINE TECHNIQUE
Batiment B1

Référence	Indice	Document	Date
DT-APD-92008004	1.0	Avant Projet Détaillé (APD)	10/04/2012
Réf. convention : 146810		Convention FTTH	



8309_GAINE TECHNIQUE
Batiment B1



8310_GAINE TECHNIQUE
Batiment B1

Référence	Indice	Document	Date
DT-APD-92008004	1.0	Avant Projet Détaillé (APD)	10/04/2012
Réf. convention : 146810		Convention FTTH	

7 - Colonne Montante 3

Lieu de la colonne	
Adresse(s) :	18 BOULEVARD DE LA REPUBLIQUE 92420 VAUCRESSON
Batiment :	18 BOULEVARD DE LA REPUBLIQUE
Étage :	0

Câblage vertical	
Type de remonté	Gaine technique
Mode de pose H	Fourreau
Inter-palier	Fourreau existant

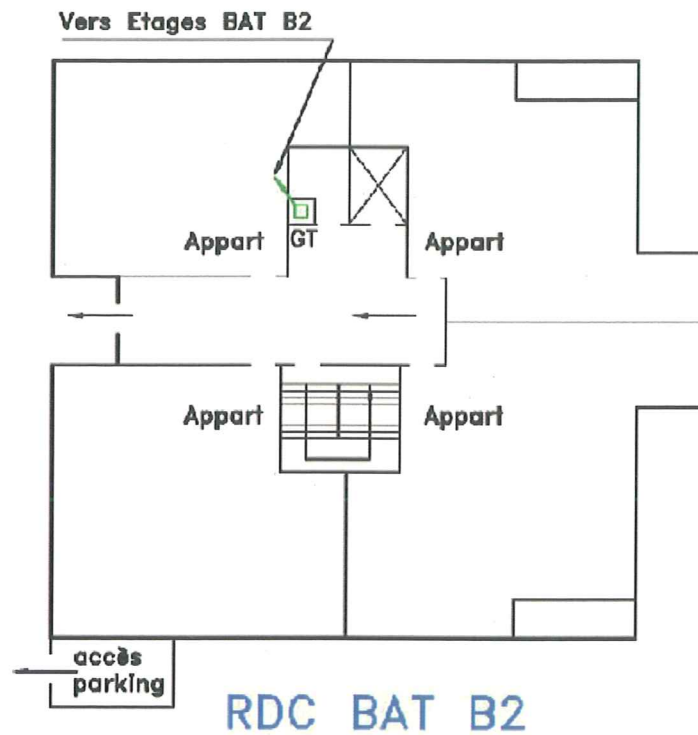

Référence	Indice	Document	Date
DT-APD-92008004	1.0	Avant Projet Détaillé (APD)	10/04/2012
Réf. convention : 146810		Convention FTTH	

Lieu de la colonne	
Adresse(s) :	18 BOULEVARD DE LA REPUBLIQUE 92420 VAUCRESSON
Batiment :	18 BOULEVARD DE LA REPUBLIQUE
Étage :	1 3

Câblage vertical	
Type de remonté	Gaine technique
Mode de pose H	Fourreau
Inter-palier	Fourreau existant

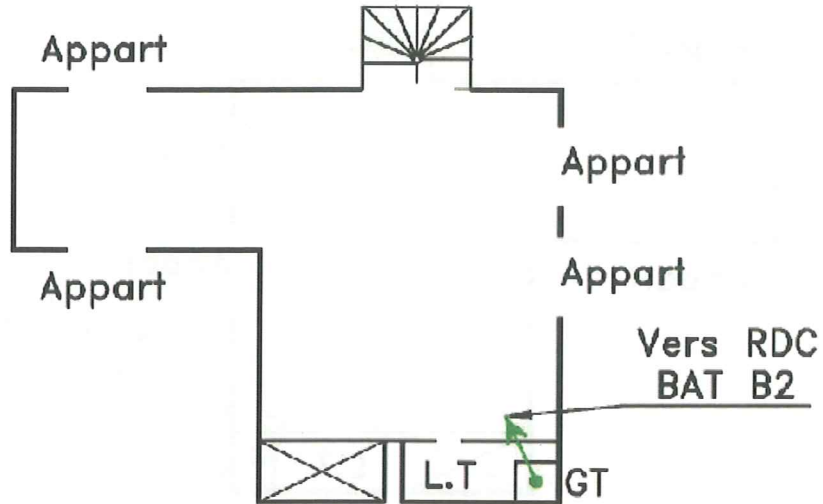

1er et 3ème étage
BAT B2

Référence	Indice	Document	Date
DT-APD-92008004	1.0	Avant Projet Détaillé (APD)	10/04/2012
Réf. convention : 146810		Convention FTTH	

Lieu de la colonne	
Adresse(s) :	18 BOULEVARD DE LA REPUBLIQUE 92420 VAUCRESSON
Batiment :	18 BOULEVARD DE LA REPUBLIQUE
Etage :	2

Câblage vertical	
Type de remonté	Gaine technique
Mode de pose H	Fourreau
Inter-palier	Fourreau existant

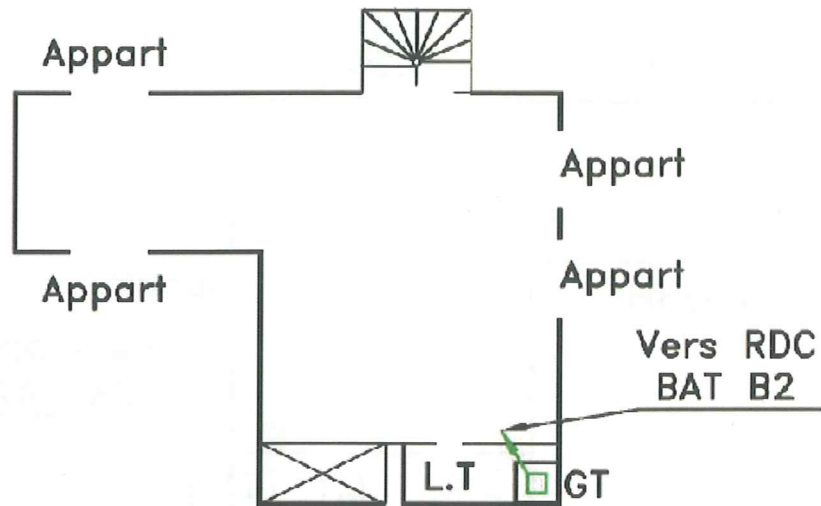

2ème étage BAT B2



8295_GAINE TECHNIQUE
Batiment B2



8296_GAINE TECHNIQUE
Batiment B2

Référence	Indice	Document	Date
DT-APD-92008004	1.0	Avant Projet Détaillé (APD)	10/04/2012
Réf. convention : 146810		Convention FTTH	



8297_GAINE TECHNIQUE
Batiment B2

Référence	Indice	Document	Date	
DT-APD-92008004	1.0	Avant Projet Détaillé (APD)	10/04/2012	
Réf. convention : 146810		Convention FTTH		

8 - Colonne Montante 4

Lieu de la colonne	
Adresse(s) :	18 BOULEVARD DE LA REPUBLIQUE 92420 VAUCRESSON
Batiment :	18 BOULEVARD DE LA REPUBLIQUE
Étage :	0

Câblage vertical	
Type de remonté	Gaine technique
Mode de pose H	Fourreau
Inter-palier	Fourreau existant

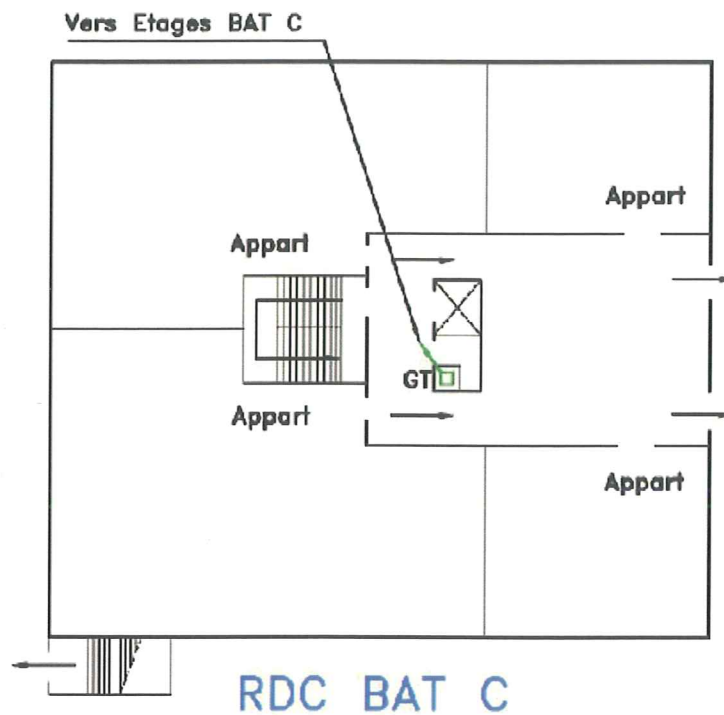

Référence	Indice	Document	Date
DT-APD-92008004	1.0	Avant Projet Détaillé (APD)	10/04/2012
Réf. convention : 146810		Convention FTTH	

Lieu de la colonne	
Adresse(s) :	18 BOULEVARD DE LA REPUBLIQUE 92420 VAUCRESSON
Batiment :	18 BOULEVARD DE LA REPUBLIQUE
Etage :	1 3

Câblage vertical	
Type de remonté	Gaine technique
Mode de pose H	Fourreau
Inter-palier	Fourreau existant

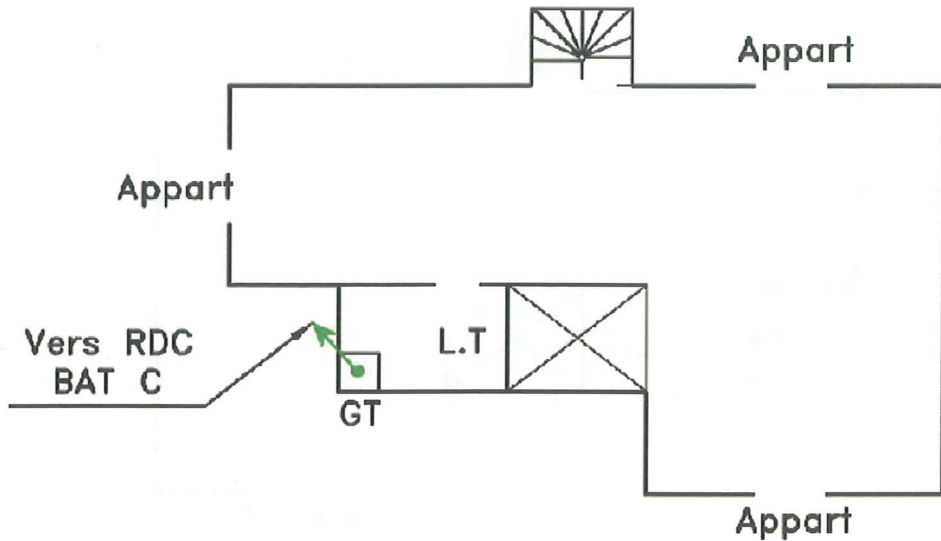

1er et 3ème étage BAT C

Référence	Indice	Document	Date
DT-APD-92008004	1.0	Avant Projet Détaillé (APD)	10/04/2012
Réf. convention : 146810		Convention FTTH	

Lieu de la colonne	
Adresse(s) :	18 BOULEVARD DE LA REPUBLIQUE 92420 VAUCRESSON
Batiment :	18 BOULEVARD DE LA REPUBLIQUE
Etage :	2

Câblage vertical	
Type de remonté	Gaine technique
Mode de pose H	Fourreau
Inter-palier	Fourreau existant

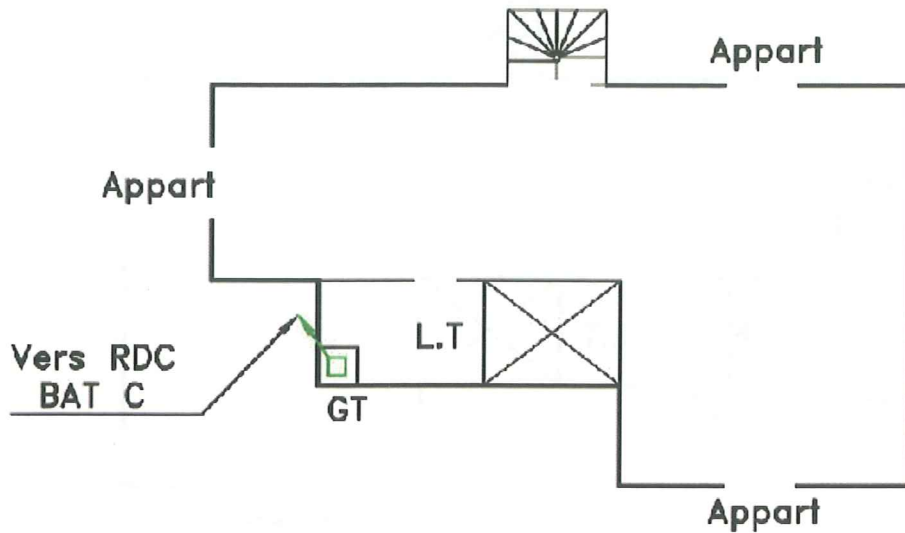

2ème étage BAT C

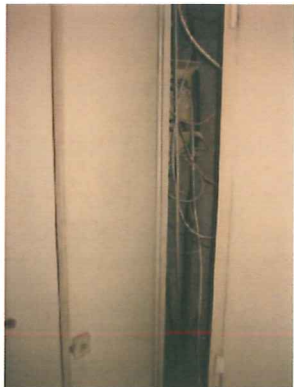

8266_GAINE TECHNIQUE
Batiment C



8267_GAINE TECHNIQUE
Batiment C

Référence	Indice	Document	Date
DT-APD-92008004	1.0	Avant Projet Détaillé (APD)	10/04/2012
Réf. convention : 146810		Convention FTTH	

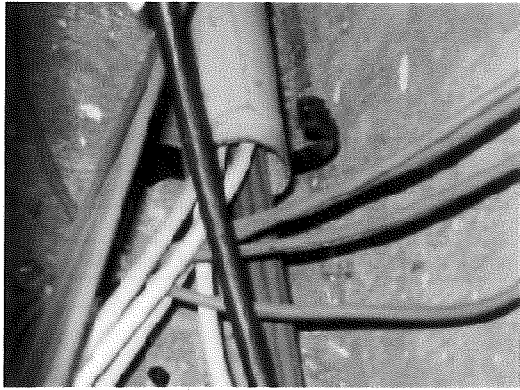

8268_GAINE TECHNIQUE
Batiment C

Référence	Indice	Document	Date	
DT-APD-92008004	1.0	Avant Projet Détaillé (APD)	10/04/2012	
Réf. convention : 146810		Convention FTTH		43/79

9 - Colonne Montante 5

Lieu de la colonne	
Adresse(s) :	18 BOULEVARD DE LA REPUBLIQUE 92420 VAUCRESSON
Batiment :	18 BOULEVARD DE LA REPUBLIQUE
Étage :	0

Câblage vertical	
Type de remonté	Gaine technique
Mode de pose H	Fourreau
Inter-palier	Fourreau existant

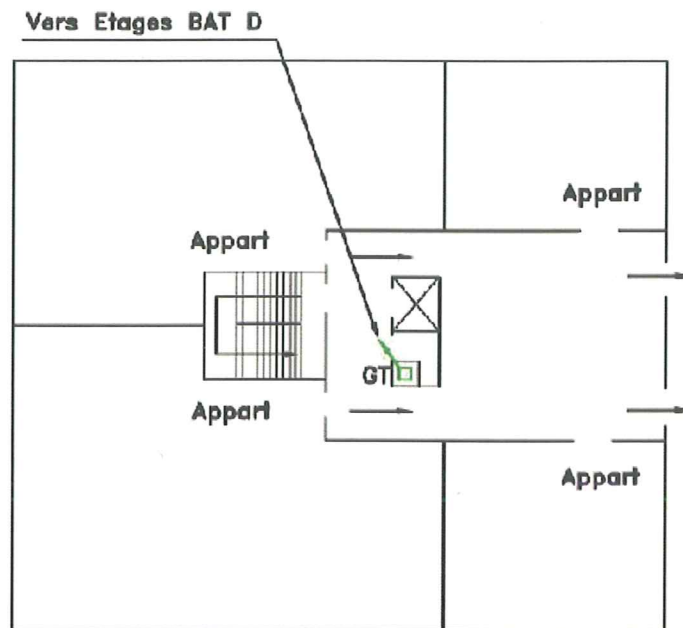

RDC BAT D

Référence	Indice	Document	Date
DT-APD-92008004	1.0	Avant Projet Détaillé (APD)	10/04/2012
Réf. convention : 146810		Convention FTTH	

Lieu de la colonne	
Adresse(s) :	18 BOULEVARD DE LA REPUBLIQUE 92420 VAUCRESSON
Batiment :	18 BOULEVARD DE LA REPUBLIQUE
Étage :	1

Câblage vertical	
Type de remonté	Gaine technique
Mode de pose H	Fourreau
Inter-palier	Fourreau existant

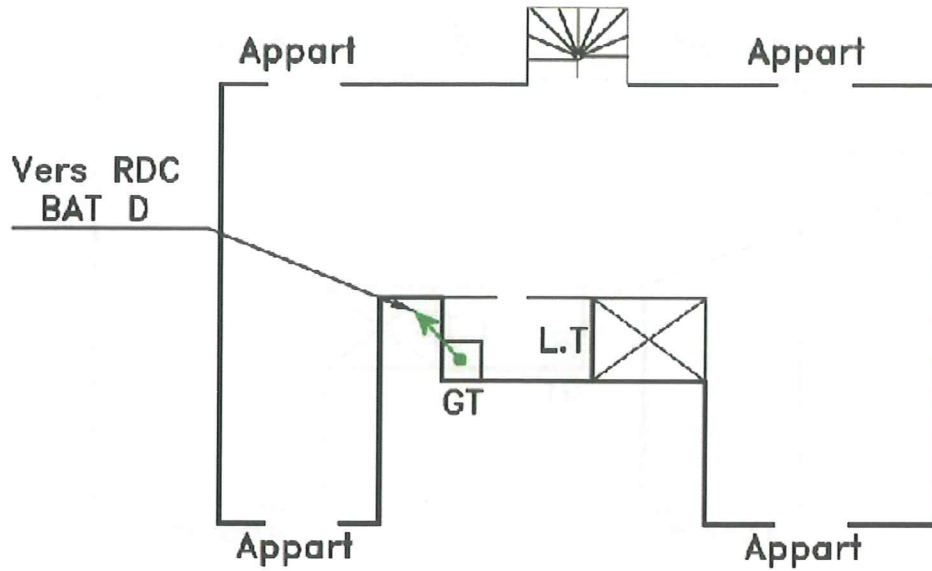

1er étage BAT D

Référence	Indice	Document	Date
DT-APD-92008004	1.0	Avant Projet Détaillé (APD)	10/04/2012
Réf. convention : 146810		Convention FTTH	

Lieu de la colonne	
Adresse(s) :	18 BOULEVARD DE LA REPUBLIQUE 92420 VAUCRESSON
Batiment :	18 BOULEVARD DE LA REPUBLIQUE
Etage :	2

Câblage vertical	
Type de remonté	Gaine technique
Mode de pose H	Fourreau
Inter-palier	Fourreau existant

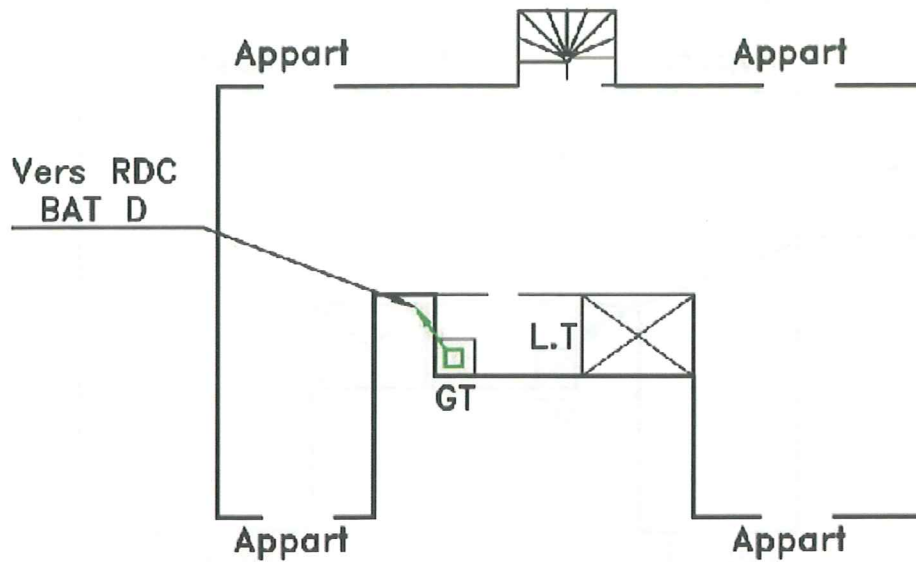

2ème étage BAT D

Référence	Indice	Document	Date
DT-APD-92008004	1.0	Avant Projet Détaillé (APD)	10/04/2012
Réf. convention : 146810		Convention FTTH	

Lieu de la colonne	
Adresse(s) :	18 BOULEVARD DE LA REPUBLIQUE 92420 VAUCRESSON
Batiment :	18 BOULEVARD DE LA REPUBLIQUE
Etage :	3

Câblage vertical	
Type de remonté	Gaine technique
Mode de pose H	Fourreau
Inter-palier	Fourreau existant

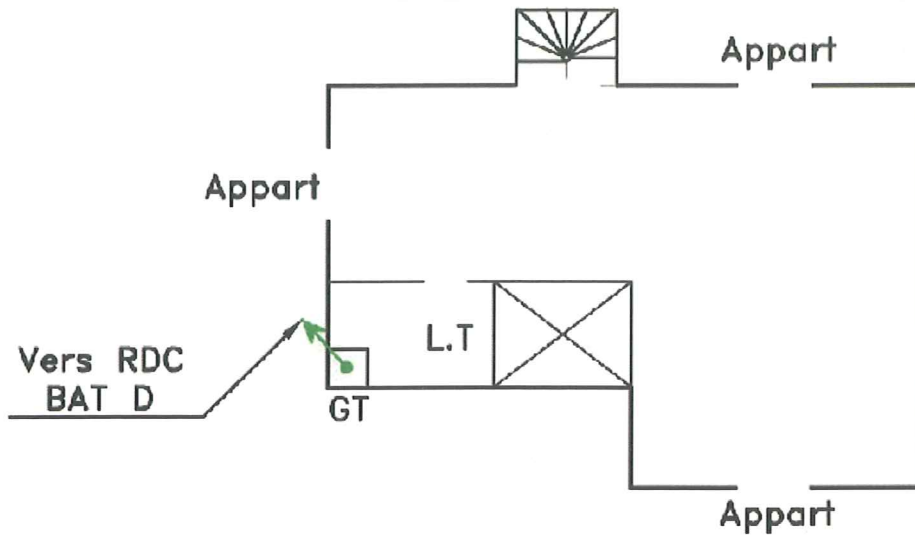

3ème étage BAT D

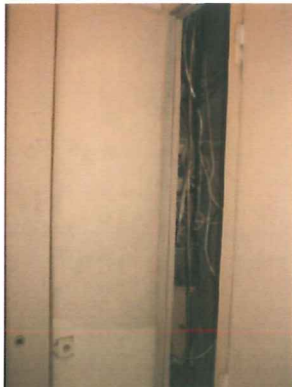

8285_GAINE TECHNIQUE
Batiment D



8286_GAINE TECHNIQUE
Batiment D

Référence	Indice	Document	Date
DT-APD-92008004	1.0	Avant Projet Détaillé (APD)	10/04/2012
Réf. convention : 146810		Convention FTTH	

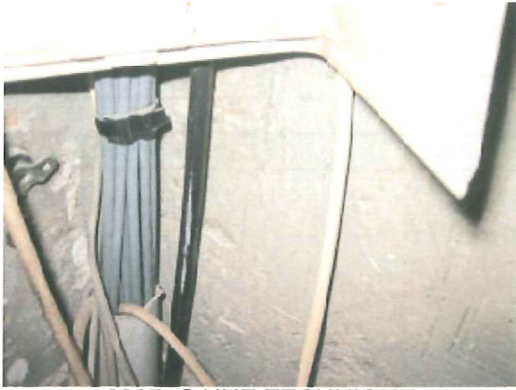

8287_GAINE TECHNIQUE
Batiment D



8288_GAINE TECHNIQUE
Batiment D

Référence	Indice	Document	Date
DT-APD-92008004	1.0	Avant Projet Détaillé (APD)	10/04/2012
Réf. convention : 146810		Convention FTTH	

10 - Colonne Montante 6

Lieu de la colonne	
Adresse(s) :	18 BOULEVARD DE LA REPUBLIQUE 92420 VAUCRESSON
Batiment :	18 BOULEVARD DE LA REPUBLIQUE
Etage :	0

Câblage vertical	
Type de remonté	Gaine technique
Mode de pose H	Fourreau
Inter-palier	Fourreau existant

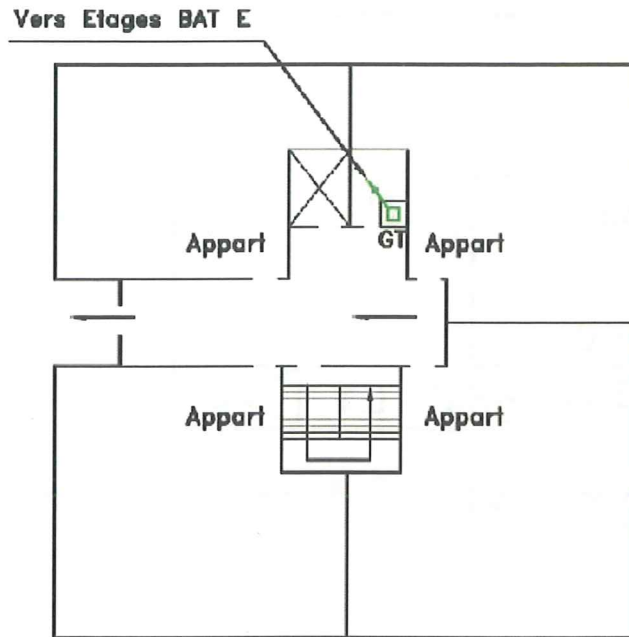

RDC BAT E

Référence	Indice	Document	Date
DT-APD-92008004	1.0	Avant Projet Détaillé (APD)	10/04/2012
Réf. convention : 146810		Convention FTTH	

Lieu de la colonne	
Adresse(s) :	18 BOULEVARD DE LA REPUBLIQUE 92420 VAUCRESSON
Batiment :	18 BOULEVARD DE LA REPUBLIQUE
Etage :	1 3

Câblage vertical	
Type de remonté	Gaine technique
Mode de pose H	Fourreau
Inter-palier	Fourreau existant

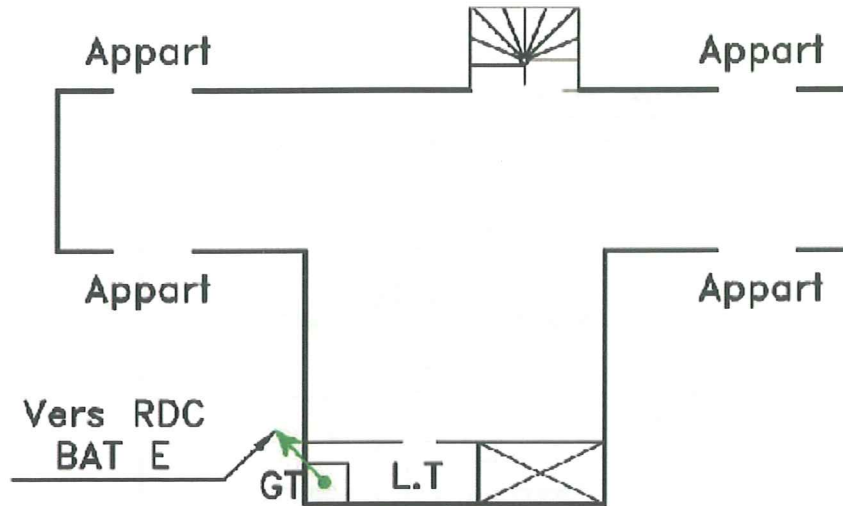

1er et 3ème étage
BAT E

Référence	Indice	Document	Date
DT-APD-92008004	1.0	Avant Projet Détaillé (APD)	10/04/2012
Réf. convention : 146810		Convention FTTH	

Lieu de la colonne	
Adresse(s) :	18 BOULEVARD DE LA REPUBLIQUE 92420 VAUCRESSON
Batiment :	18 BOULEVARD DE LA REPUBLIQUE
Etage :	2

Câblage vertical	
Type de remonté	Gaine technique
Mode de pose H	Fourreau
Inter-palier	Fourreau existant

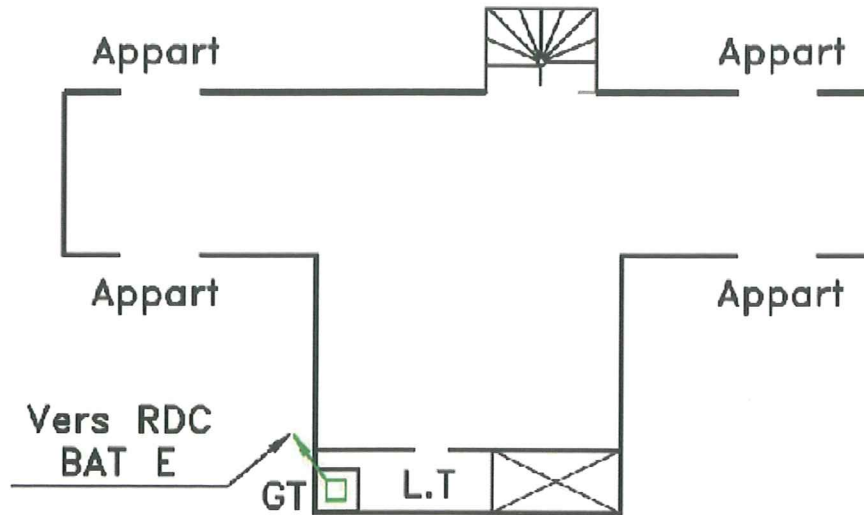

2ème étage BAT E



8273_GAINE TECHNIQUE
Batiment E



8274_GAINE TECHNIQUE
Batiment E

Référence	Indice	Document	Date
DT-APD-92008004	1.0	Avant Projet Détaillé (APD)	10/04/2012
Réf. convention : 146810		Convention FTTH	



8275_GAINE TECHNIQUE
Batiment E

Référence	Indice	Document	Date	
DT-APD-92008004	1.0	Avant Projet Détaillé (APD)	10/04/2012	
Réf. convention : 146810		Convention FTTH		52/79

11 - Colonne Montante 7

Lieu de la colonne	
Adresse(s) :	18 BOULEVARD DE LA REPUBLIQUE 92420 VAUCRESSON
Batiment :	18 BOULEVARD DE LA REPUBLIQUE
Etage :	0

Câblage vertical	
Type de remonté	Gaine technique
Mode de pose H	Fourreau
Inter-palier	Fourreau existant

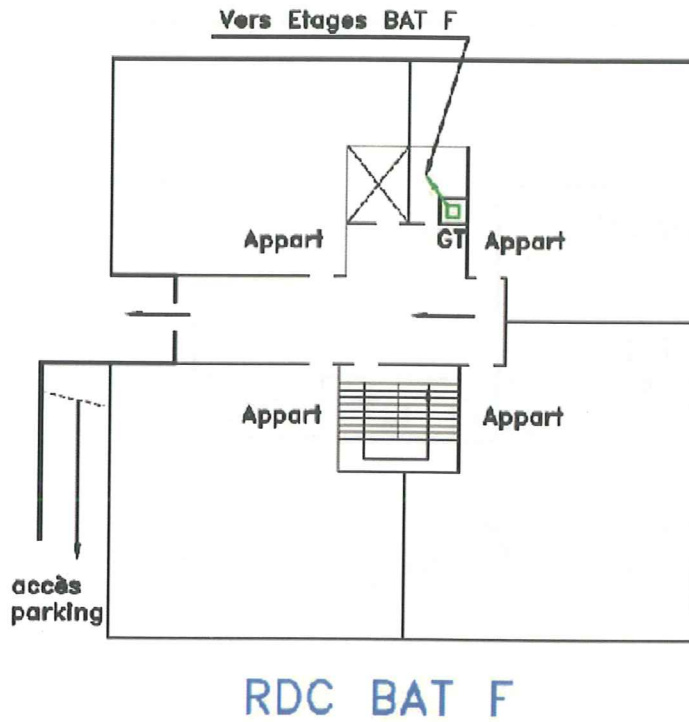

Référence	Indice	Document	Date
DT-APD-92008004	1.0	Avant Projet Détaillé (APD)	10/04/2012
Réf. convention : 146810		Convention FTTH	

Lieu de la colonne	
Adresse(s) :	18 BOULEVARD DE LA REPUBLIQUE 92420 VAUCRESSON
Batiment :	18 BOULEVARD DE LA REPUBLIQUE
Étage :	1

Câblage vertical	
Type de remonté	Gaine technique
Mode de pose H	Fourreau
Inter-palier	Fourreau existant

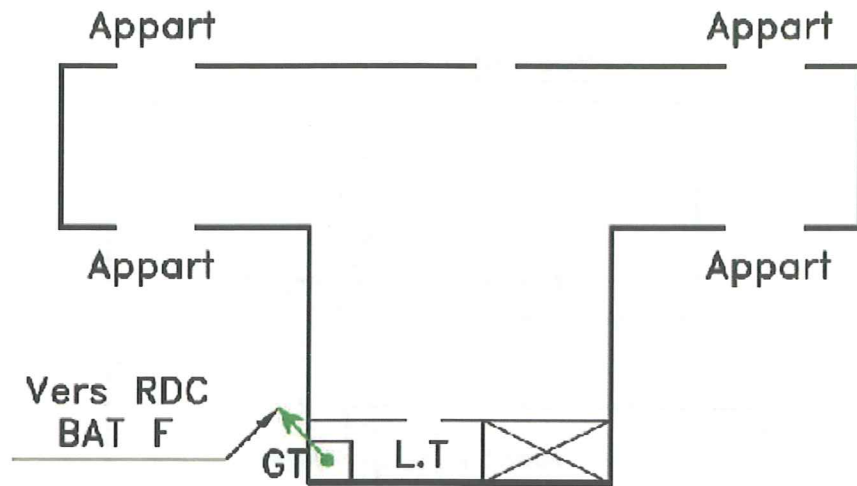

1er étage BAT F

Référence	Indice	Document	Date
DT-APD-92008004	1.0	Avant Projet Détaillé (APD)	10/04/2012
Réf. convention : 146810		Convention FTTH	

Lieu de la colonne	
Adresse(s) :	18 BOULEVARD DE LA REPUBLIQUE 92420 VAUCRESSON
Batiment :	18 BOULEVARD DE LA REPUBLIQUE
Etage :	2

Câblage vertical	
Type de remonté	Gaine technique
Mode de pose H	Fourreau
Inter-palier	Fourreau existant

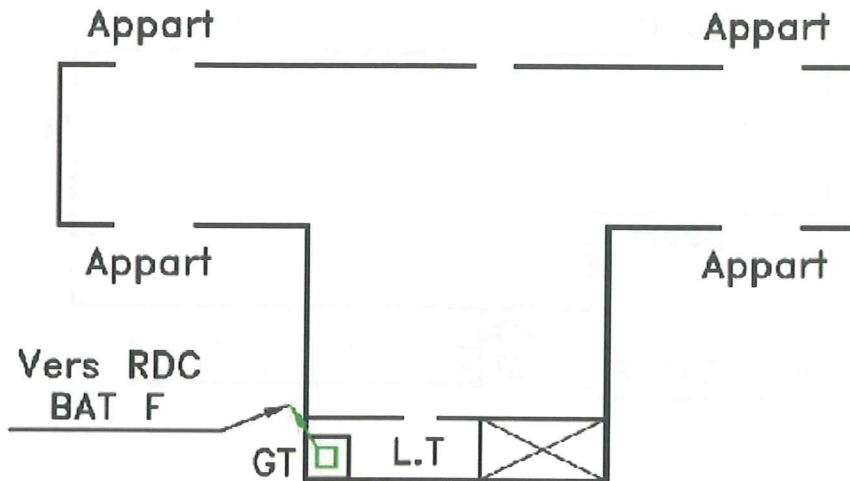

2ème étage BAT F

Référence	Indice	Document	Date
DT-APD-92008004	1.0	Avant Projet Détaillé (APD)	10/04/2012
Réf. convention : 146810		Convention FTTH	

Lieu de la colonne	
Adresse(s) :	18 BOULEVARD DE LA REPUBLIQUE 92420 VAUCRESSON
Batiment :	18 BOULEVARD DE LA REPUBLIQUE
Étage :	3

Câblage vertical	
Type de remonté	Gaine technique
Mode de pose H	Fourreau
Inter-palier	Fourreau existant

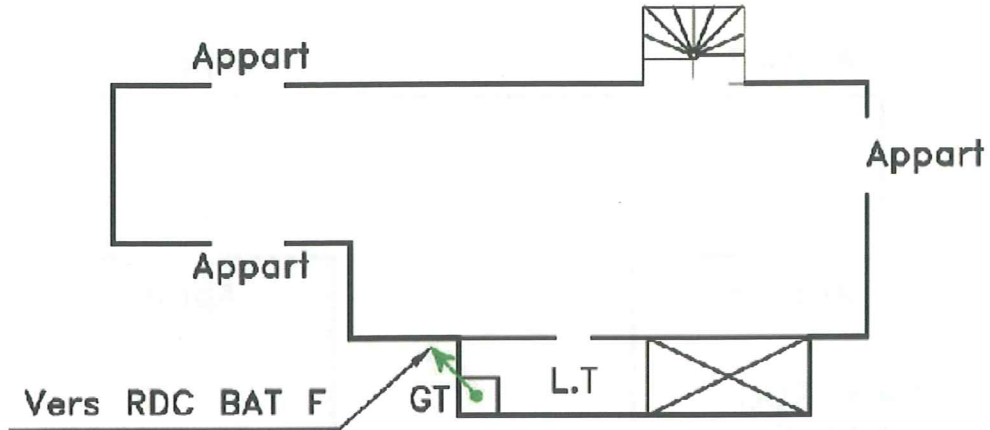

3ème étage BAT F



8234_GAINE TECHNIQUE
Batiment F



8235_GAINE TECHNIQUE
Batiment F

Référence	Indice	Document	Date
DT-APD-92008004	1.0	Avant Projet Détaillé (APD)	10/04/2012
Réf. convention : 146810		Convention FTTH	



8236_GAINE TECHNIQUE
Batiment F



8238_GAINE TECHNIQUE
Batiment F

Référence	Indice	Document	Date
DT-APD-92008004	1.0	Avant Projet Détaillé (APD)	10/04/2012
Réf. convention : 146810		Convention FTTH	

12 - Colonne Montante 8

Lieu de la colonne	
Adresse(s) :	18 BOULEVARD DE LA REPUBLIQUE 92420 VAUCRESSON
Batiment :	18 BOULEVARD DE LA REPUBLIQUE
Étage :	0

Câblage vertical	
Type de remonté	Gaine technique
Mode de pose H	Fourreau
Inter-palier	Fourreau existant

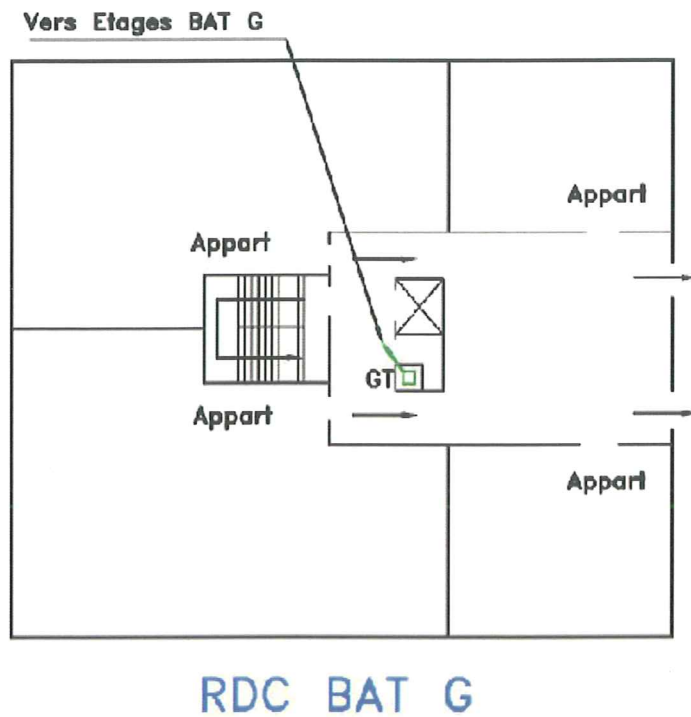

Référence	Indice	Document	Date
DT-APD-92008004	1.0	Avant Projet Détaillé (APD)	10/04/2012
Réf. convention : 146810		Convention FTTH	

RESEAU TRES HAUT DEBIT EN FIBRE OPTIQUE - DOSSIER TECHNIQUE FTTH

Lieu de la colonne	
Adresse(s) :	18 BOULEVARD DE LA REPUBLIQUE 92420 VAUCRESSON
Batiment :	18 BOULEVARD DE LA REPUBLIQUE
Etage :	1

Câblage vertical	
Type de remonté	Gaine technique
Mode de pose H	Fourreau
Inter-palier	Fourreau existant

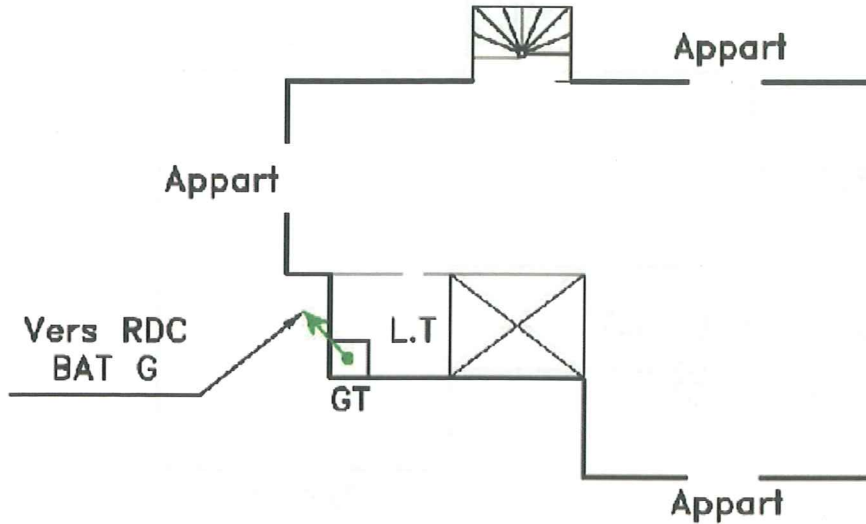

1er étage BAT G

Référence	Indice	Document	Date
DT-APD-92008004	1.0	Avant Projet Détaillé (APD)	10/04/2012
Réf. convention : 146810		Convention FTTH	

Lieu de la colonne	
Adresse(s) :	18 BOULEVARD DE LA REPUBLIQUE 92420 VAUCRESSON
Batiment :	18 BOULEVARD DE LA REPUBLIQUE
Etage :	2

Câblage vertical	
Type de remonté	Gaine technique
Mode de pose H	Fourreau
Inter-palier	Fourreau existant

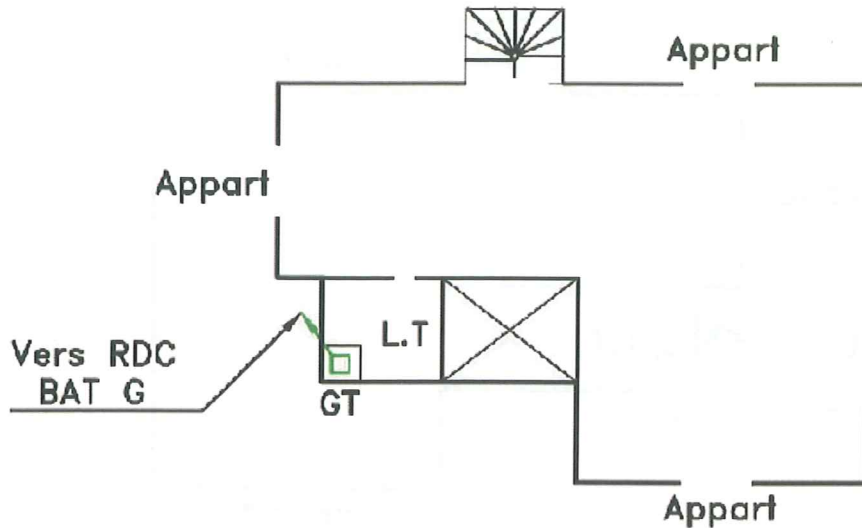

2ème étage BAT G

Référence	Indice	Document	Date
DT-APD-92008004	1.0	Avant Projet Détaillé (APD)	10/04/2012
Réf. convention : 146810		Convention FTTH	

RESEAU TRES HAUT DEBIT EN FIBRE OPTIQUE - DOSSIER TECHNIQUE FTTH

Lieu de la colonne	
Adresse(s) :	18 BOULEVARD DE LA REPUBLIQUE 92420 VAUCRESSON
Batiment :	18 BOULEVARD DE LA REPUBLIQUE
Etage :	3

Câblage vertical	
Type de remonté	Gaine technique
Mode de pose H	Fourreau
Inter-palier	Fourreau existant

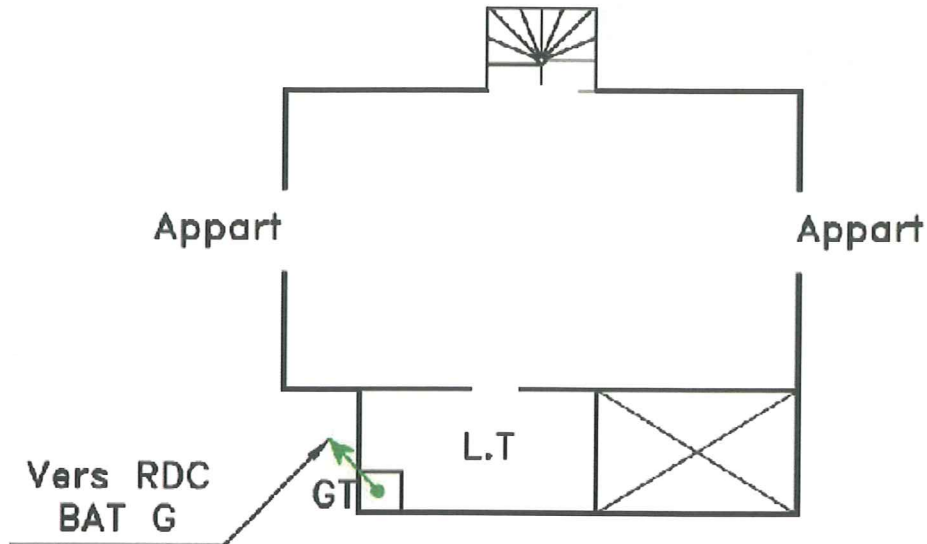

3ème étage BAT G



8257_GAINE TECHNIQUE
Batiment G



8258_GAINE TECHNIQUE
Batiment G

Référence	Indice	Document	Date
DT-APD-92008004	1.0	Avant Projet Détaillé (APD)	10/04/2012
Réf. convention : 146810		Convention FTTH	

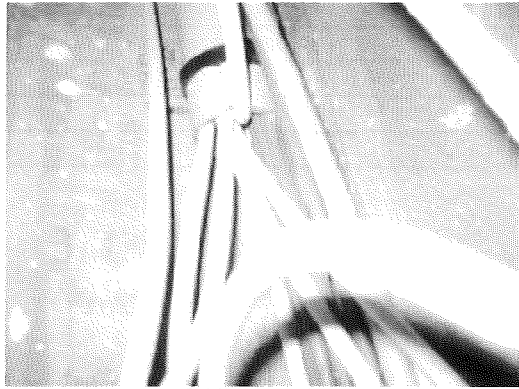

8259_GAINE TECHNIQUE
Batiment G

Référence	Indice	Document	Date	
DT-APD-92008004	1.0	Avant Projet Détaillé (APD)	10/04/2012	
Réf. convention : 146810		Convention FTTH		

13 - Colonne Montante 9

Lieu de la colonne	
Adresse(s) :	18 BOULEVARD DE LA REPUBLIQUE 92420 VAUCRESSON
Batiment :	18 BOULEVARD DE LA REPUBLIQUE
Étage :	0

Câblage vertical	
Type de remonté	Gaine technique
Mode de pose H	Fourreau
Inter-palier	Fourreau existant

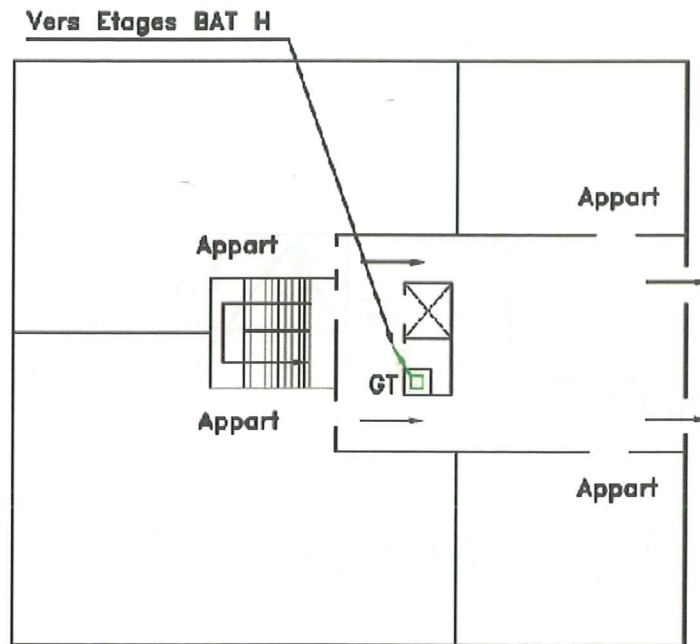

RDC BAT H

Référence	Indice	Document	Date
DT-APD-92008004	1.0	Avant Projet Détaillé (APD)	10/04/2012
Réf. convention : 146810		Convention FTTH	

Lieu de la colonne	
Adresse(s) :	18 BOULEVARD DE LA REPUBLIQUE 92420 VAUCRESSON
Batiment :	18 BOULEVARD DE LA REPUBLIQUE
Etage :	1

Câblage vertical	
Type de remonté	Gaine technique
Mode de pose H	Fourreau
Inter-palier	Fourreau existant

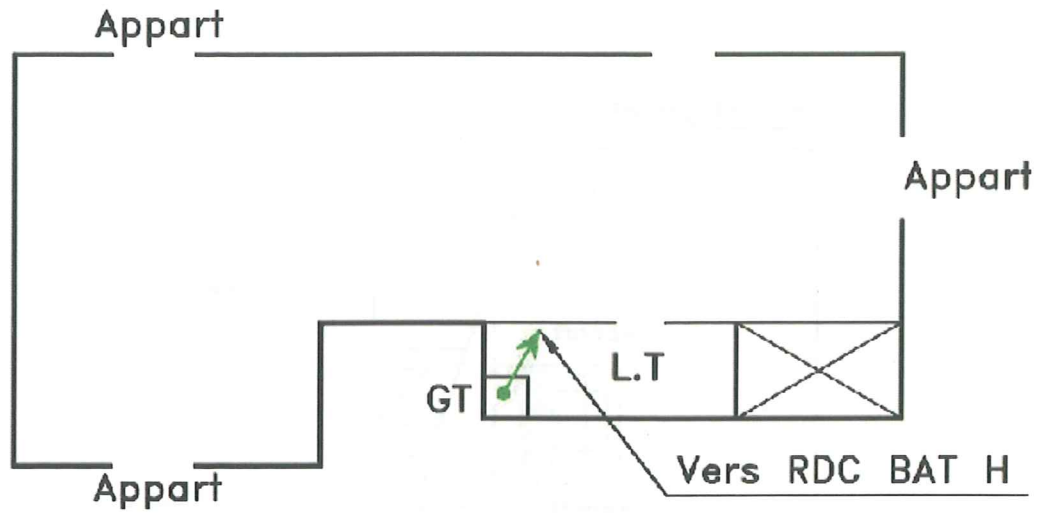

1er étage BAT H

Référence	Indice	Document	Date
DT-APD-92008004	1.0	Avant Projet Détaillé (APD)	10/04/2012
Réf. convention : 146810		Convention FTTH	

Lieu de la colonne	
Adresse(s) :	18 BOULEVARD DE LA REPUBLIQUE 92420 VAUCRESSON
Batiment :	18 BOULEVARD DE LA REPUBLIQUE
Etage :	2

Câblage vertical	
Type de remonté	Gaine technique
Mode de pose H	Fourreau
Inter-palier	Fourreau existant

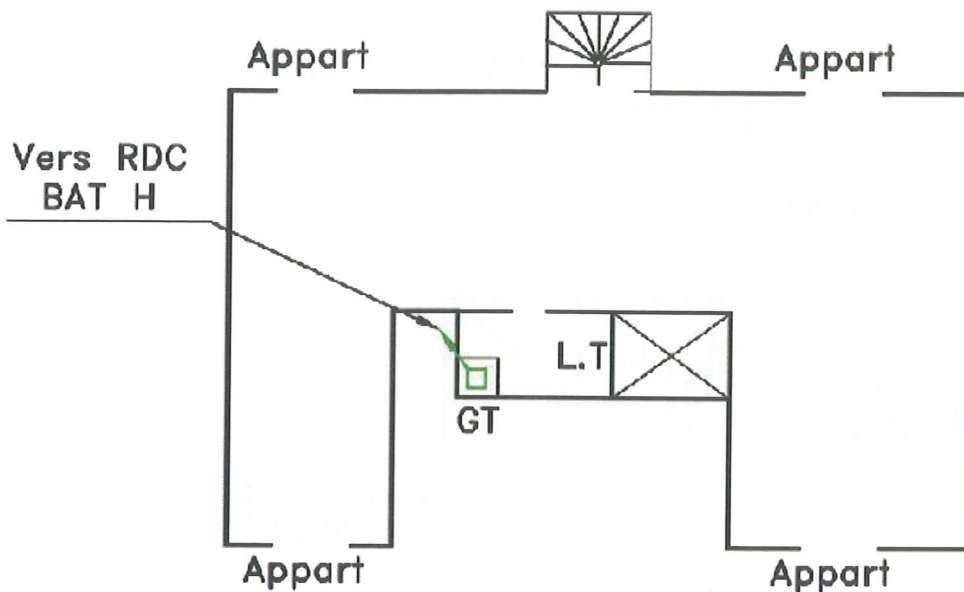

2ème étage BAT H

Référence	Indice	Document	Date
DT-APD-92008004	1.0	Avant Projet Détaillé (APD)	10/04/2012
Réf. convention : 146810		Convention FTTH	

Lieu de la colonne	
Adresse(s) :	18 BOULEVARD DE LA REPUBLIQUE 92420 VAUCRESSON
Batiment :	18 BOULEVARD DE LA REPUBLIQUE
Etage :	3

Câblage vertical	
Type de remonté	Gaine technique
Mode de pose H	Fourreau
Inter-palier	Fourreau existant

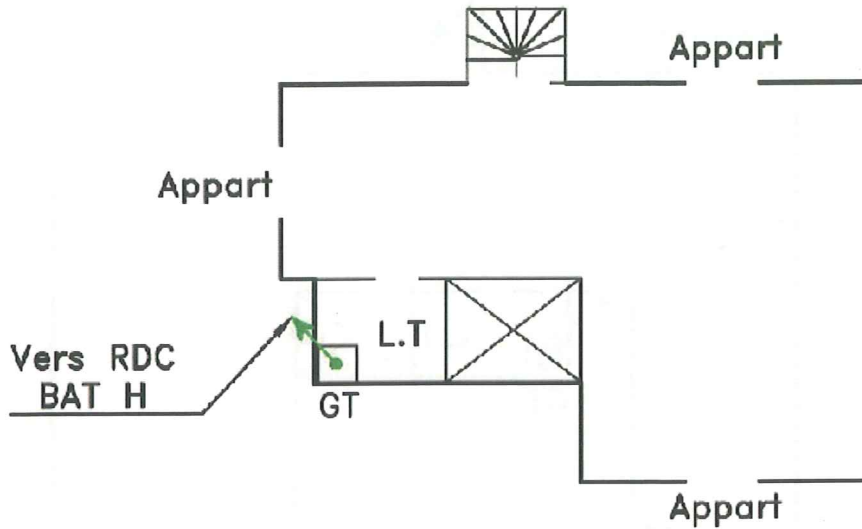

3ème étage BAT H



8248_GAINE TECHNIQUE
Batiment H



8249_GAINE TECHNIQUE
Batiment H

Référence	Indice	Document	Date
DT-APD-92008004	1.0	Avant Projet Détaillé (APD)	10/04/2012
Réf. convention : 146810		Convention FTTH	



8250_GAINE TECHNIQUE
Batiment H



8251_GAINE TECHNIQUE
Batiment H

Référence	Indice	Document	Date
DT-APD-92008004	1.0	Avant Projet Détaillé (APD)	10/04/2012
Réf. convention : 146810		Convention FTTH	

14 - Branchement des abonnés

Colonne 1

Adresse(s) :	18 DE LA REPUBLIQUE 92420 VAUCRESSON
Batiment :	18 BOULEVARD DE LA REPUBLIQUE

Câblage horizontal - Branchement abonnés					
Infrastructure existante		Inter-palier		Distance PBO-Paliers	
Type pose H	Occupation	Type	Occupation	Min	Max
Autre		Autre		5m	8m

Infrastructure à créer		
Type	Quantité	Commentaire



8313_DISTRIBUTION APPARTEMENT

batiment a



8314_DISTRIBUTION APPARTEMENT

batiment a



8315_DISTRIBUTION APPARTEMENT

batiment a

Référence	Indice	Document	Date	
DT-APD-92008004	1.0	Avant Projet Détaillé (APD)	10/04/2012	
Réf. convention : 146810		Convention FTTH		

Colonne 2

Adresse(s) :	18 DE LA REPUBLIQUE 92420 VAUCRESSON
Batiment :	18 BOULEVARD DE LA REPUBLIQUE

Câblage horizontal - Branchement abonnés

Infrastructure existante		Inter-palier		Distance PBO-Paliers	
Type pose H	Occupation	Type	Occupation	Min	Max
Autre		Autre		5m	8m

Infrastructure à créer

Type	Quantité	Commentaire
------	----------	-------------



8303_DISTRIBUTION APPARTEMENT

batiment b1



8304_DISTRIBUTION APPARTEMENT

batiment b1



8305_DISTRIBUTION APPARTEMENT

batiment b1



8306_DISTRIBUTION APPARTEMENT

batiment b1

Référence	Indice	Document	Date
DT-APD-92008004	1.0	Avant Projet Détaillé (APD)	10/04/2012
Réf. convention : 146810		Convention FTTH	

Colonne 3

Adresse(s) :	18 DE LA REPUBLIQUE 92420 VAUCRESSON
Batiment :	18 BOULEVARD DE LA REPUBLIQUE

Câblage horizontal - Branchement abonnés					
Infrastructure existante		Inter-palier		Distance PBO-Paliers	
Type pose H	Occupation	Type	Occupation	Min	Max
Autre		Autre		5m	8m

Infrastructure à créer		
Type	Quantité	Commentaire



8292_DISTRIBUTION APPARTEMENT

batiment b2



8293_DISTRIBUTION APPARTEMENT

batiment b2



8294_DISTRIBUTION APPARTEMENT

batiment b2

Référence	Indice	Document	Date
DT-APD-92008004	1.0	Avant Projet Détaillé (APD)	10/04/2012
Réf. convention : 146810		Convention FTTH	

Colonne 4

Adresse(s) :	18 DE LA REPUBLIQUE 92420 VAUCRESSON
Batiment :	18 BOULEVARD DE LA REPUBLIQUE

Câblage horizontal - Branchement abonnés

Infrastructure existante		Inter-palier		Distance PBO-Paliers	
Type pose H	Occupation	Type	Occupation	Min	Max
Autre		Autre		5m	8m

Infrastructure à créer

Type	Quantité	Commentaire
------	----------	-------------



8263_DISTRIBUTION APPARTEMENT

batiment c



8264_DISTRIBUTION APPARTEMENT

batiment c



8265_DISTRIBUTION APPARTEMENT

batiment c

Référence	Indice	Document	Date
DT-APD-92008004	1.0	Avant Projet Détaillé (APD)	10/04/2012
Réf. convention : 146810		Convention FTTH	

Colonne 5

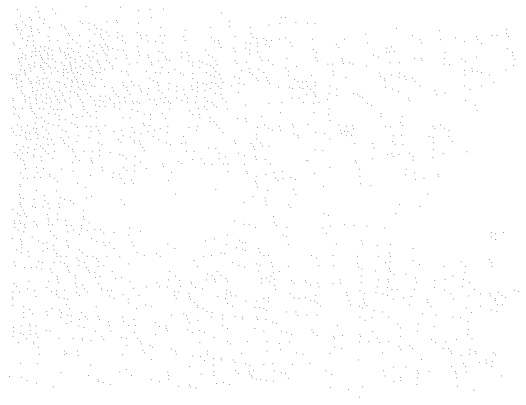
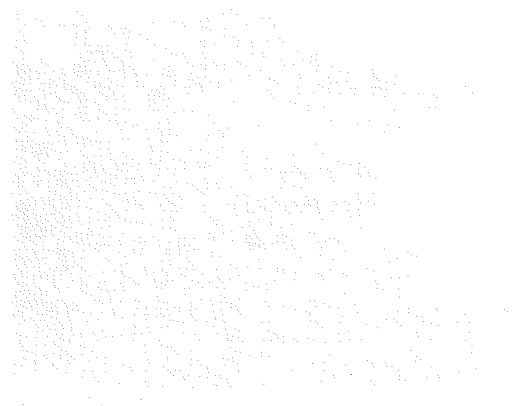
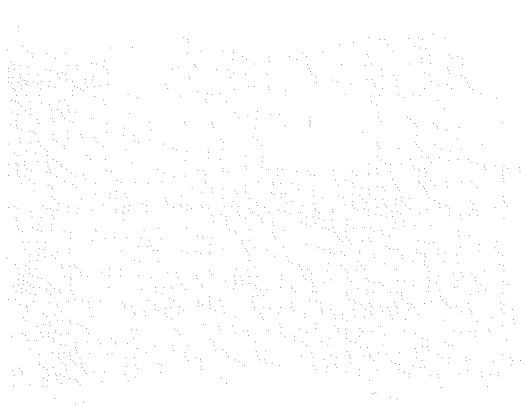

Adresse(s) :	18 DE LA REPUBLIQUE 92420 VAUCRESSON
Batiment :	18 BOULEVARD DE LA REPUBLIQUE

Câblage horizontal - Branchement abonnés					
Infrastructure existante		Inter-palier		Distance PBO-Paliers	
Type	pose H	Type	Occupation	Min	Max
Autre		Autre		5m	8m

Infrastructure à créer		
Type	Quantité	Commentaire



8280_DISTRIBUTION APPARTEMENT

batiment d



8281_DISTRIBUTION APPARTEMENT

batiment d



8282_DISTRIBUTION APPARTEMENT

batiment d



8283_DISTRIBUTION APPARTEMENT

batiment d



8284_DISTRIBUTION APPARTEMENT

batiment d

Référence	Indice	Document	Date
DT-APD-92008004	1.0	Avant Projet Détaillé (APD)	10/04/2012
Réf. convention : 146810		Convention FTTH	

Colonne 6

Adresse(s) :	18 DE LA REPUBLIQUE 92420 VAUCRESSON
Batiment :	18 BOULEVARD DE LA REPUBLIQUE

Câblage horizontal - Branchement abonnés					
Infrastructure existante		Inter-palier		Distance PBO-Paliers	
Type pose H	Occupation	Type	Occupation	Min	Max
Autre		Autre		5m	8m

Infrastructure à créer		
Type	Quantité	Commentaire



8271_DISTRIBUTION APPARTEMENT

batiment e



8272_DISTRIBUTION APPARTEMENT

batiment e

Référence	Indice	Document	Date
DT-APD-92008004	1.0	Avant Projet Détaillé (APD)	10/04/2012
Réf. convention : 146810		Convention FTTH	

Colonne 7

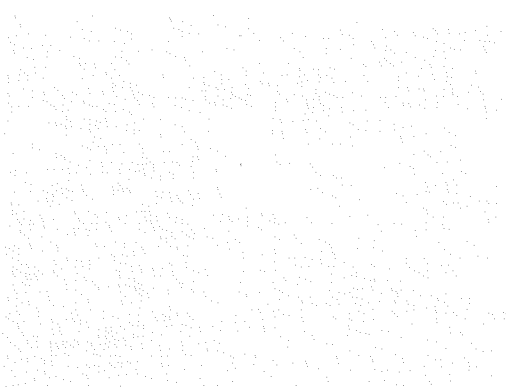
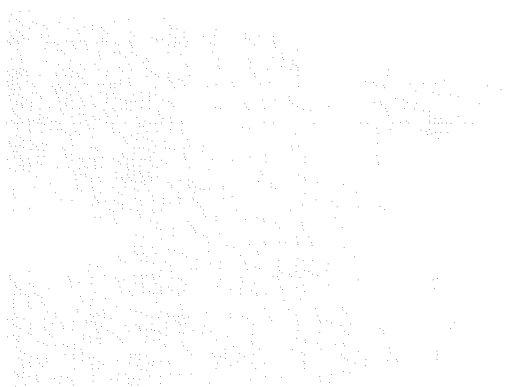
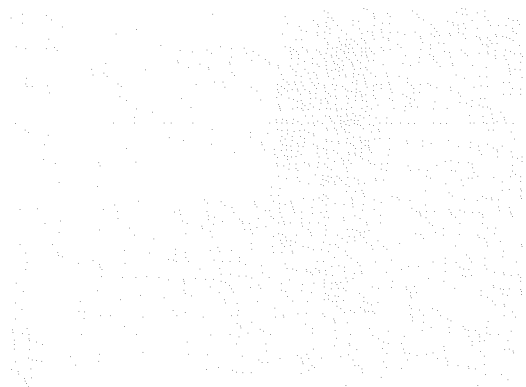
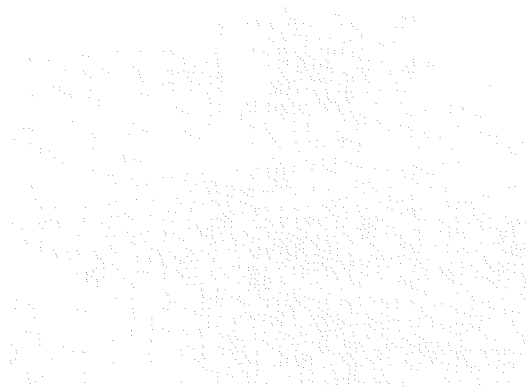

Adresse(s) :	18 DE LA REPUBLIQUE 92420 VAUCRESSON
Batiment :	18 BOULEVARD DE LA REPUBLIQUE

Câblage horizontal - Branchement abonnés					
Infrastructure existante		Inter-palier		Distance PBO-Paliers	
Type pose H	Occupation	Type	Occupation	Min	Max
Autre		Autre		5m	8m

Infrastructure à créer		
Type	Quantité	Commentaire



8228_DISTRIBUTION APPARTEMENT

batiment f



8229_DISTRIBUTION APPARTEMENT

batiment f



8230_DISTRIBUTION APPARTEMENT

batiment f



8231_DISTRIBUTION APPARTEMENT

batiment f



8232_DISTRIBUTION APPARTEMENT

batiment f



8233_DISTRIBUTION APPARTEMENT

batiment f

Référence	Indice	Document	Date	
DT-APD-92008004	1.0	Avant Projet Détaillé (APD)	10/04/2012	
Réf. convention : 146810		Convention FTTH		76/79

Colonne 8

Adresse(s) :	18 DE LA REPUBLIQUE 92420 VAUCRESSON
Batiment :	18 BOULEVARD DE LA REPUBLIQUE

Câblage horizontal - Branchement abonnés					
Infrastructure existante		Inter-palier		Distance PBO-Paliers	
Type pose H	Occupation	Type	Occupation	Min	Max
Autre		Autre		5m	8m

Infrastructure à créer		
Type	Quantité	Commentaire



8253_DISTRIBUTION APPARTEMENT

batiment g



8254_DISTRIBUTION APPARTEMENT

batiment g



8255_DISTRIBUTION APPARTEMENT

batiment g



8256_DISTRIBUTION APPARTEMENT

batiment g

Référence	Indice	Document	Date
DT-APD-92008004	1.0	Avant Projet Détaillé (APD)	10/04/2012
Réf. convention : 146810		Convention FTTH	

Colonne 9

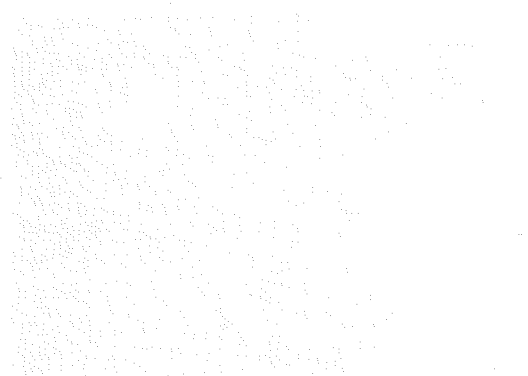
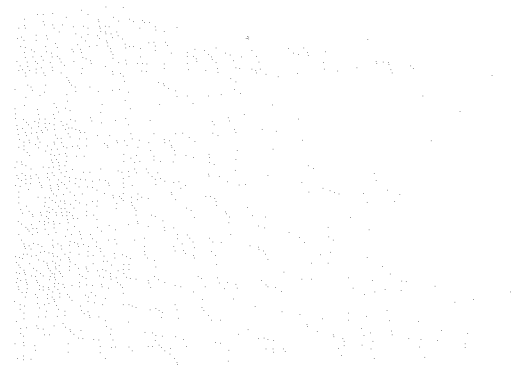
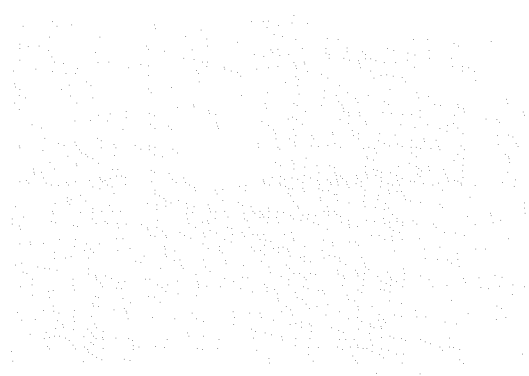

Adresse(s) :	18 DE LA REPUBLIQUE 92420 VAUCRESSON
Batiment :	18 BOULEVARD DE LA REPUBLIQUE

Câblage horizontal - Branchement abonnés					
Infrastructure existante		Inter-palier		Distance PBO-Paliers	
Type	pose H	Type	Occupation	Min	Max
Autre		Autre		5m	8m

Infrastructure à créer		
Type	Quantité	Commentaire



8242_DISTRIBUTION APPARTEMENT

batiment h



8243_DISTRIBUTION APPARTEMENT

batiment h



8244_DISTRIBUTION APPARTEMENT

batiment h



8245_DISTRIBUTION APPARTEMENT

batiment h



8246_DISTRIBUTION APPARTEMENT

batiment h



8247_DISTRIBUTION APPARTEMENT

batiment h

Référence	Indice	Document	Date
DT-APD-92008004	1.0	Avant Projet Détaillé (APD)	10/04/2012
Réf. convention : 146810		Convention FTTH	